

DENSO



Bar Code Handy Terminal

BHT-202B-CE/202BW-CE

User's Manual

If you leave the BHT with the battery cartridge discharged or with no battery cartridge loaded or if you replace the battery cartridge in a wrong way, the BHT may lose the data stored in it.

Before cold booting (refer to Chapter 2, Section 2.3.5 "Warm and Cold Booting"), it is recommended that important data be saved into the FLASH folder or uploaded to the host computer. Cold booting will erase all data stored in the RAM.

-
- DENSO WAVE INCORPORATED does not assume any product liability arising out of, or in connection with, the application or use of any product, circuit, or application described herein.
 - If it is judged by DENSO WAVE INCORPORATED that malfunction of the product is due to the product having been dropped or subjected to impact, repairs will be made at a reasonable charge even within the warranty period.

- Intellectual Property Precaution

DENSO WAVE INCORPORATED ("DENSO WAVE") takes reasonable precautions to ensure its products do not infringe upon any patent or other intellectual property rights of other(s), but DENSO WAVE cannot be responsible for any patent or other intellectual property right infringement(s) or violation(s) which arise from (i) the use of DENSO WAVE's product(s) in connection or in combination with other component(s), product(s), data processing system(s) or equipment or software not supplied from DENSO WAVE; (ii) the use of DENSO WAVE's products in a manner for which the same were not intended nor designed; or (iii) any modification of DENSO WAVE's products by other(s) than DENSO WAVE.

- Limited Warranty on Software Products

In no event will DENSO WAVE INCORPORATED be liable for direct, indirect, special, incidental, or consequential damages (including imaginary profits or damages resulting from interruption of operation or loss of business information) resulting from any defect in the software or its documentation or resulting from inability to apply the software or its documentation.

Copyright © DENSO WAVE INCORPORATED, 2006

All rights reserved. No part of this publication may be reproduced in any form or by any means without permission in writing from the publisher.

Specifications are subject to change without prior notice.

All products and company names mentioned in this manual are trademarks or registered trademarks of their respective holders.

The latest precision manufacturing technology yields LCD panels whose pixels are 99.99% defect free. The downside, note, is that up to 0.01% of the pixels can remain permanently dark or lit on today's state-of-the-art panels.

A thin Newton's rings (rainbow-like patterns) may appear on the touch screen.

This does not necessarily indicate a problem with the touch screen.

US and Canada Regulations

This device complies with Part 15 of the FCC Rules, Canadian ICES-003 and RSS-210 Rules.

Operation is subject to the following two conditions:

- (1) this device may not cause harmful interference, and
- (2) this device must accept any interference received, including interference that may cause undesired operation.

NOTE: This equipment has been tested and found to comply with the limits for a Class A digital device, pursuant to Part 15 of the FCC Rules. These limits are designed to provide reasonable protection against harmful interference when the equipment is operated in a commercial environment. This equipment generates, uses, and can radiate radio frequency energy and, if not installed and used in accordance with the instruction manual, may cause harmful interference to radio communications. Operation of this equipment in a residential area is likely to cause harmful interference in which case the user will be required to correct the interference at his own expense.

NOTE: This Class A digital apparatus complies with Canadian ICES-003.

Cet appareil numérique de la classe A est conforme à la norme NMB-003 du Canada.

FCC WARNING: Changes or modifications not expressly approved by the party responsible for compliance could void the user's authority to operate the equipment.

CAUTION: Radio Frequency Radiation Exposure

This device is approved for hand held use only and, to comply with applicable FCC radio frequency exposure regulations, must be used with a distance of at least 20 cm (7.9 inches) between the antenna and the body of any person at all times during use.

This transmitter and its antenna should not be placed next to other antennas or similar radiating structures.

LABELING:

For USA and Canada

CONTAINS - FCC ID : H9PLA4137
 - CANADA : 1549104431A

THIS DEVICE COMPLIES WITH PART 15 OF THE FCC RULES. OPERATION IS SUBJECT TO THE FOLLOWING TWO CONDITIONS: (1) THIS DEVICE MAY NOT CAUSE HARMFUL INTERFERENCE, AND (2) THIS DEVICE MUST ACCEPT ANY INTERFERENCE RECEIVED, INCLUDING INTERFERENCE THAT MAY CAUSE UNDESIRABLE OPERATION. THIS DEVICE COMPLIES WITH RSS-210. THIS CLASS A DIGITAL APPARATUS COMPLIES WITH CANADIAN ICES-001. CET APPAREIL NUMÉRIQUE DE LA CLASSE A EST CONFORME À LA NORME NMB-001 DU CANADA.

For USA and Canada

 LASER RADIATION-DO NOT STARE INTO BEAM
 OF THIS DIRECTLY VIEWING INSTRUMENTS
 CLASS II LASER PRODUCT MAXIMUM OUTPUT: 5MILLI WATTS
 IEC60825-1:1993/FA2:2001

THIS DEVICE COMPLIES WITH 21 CFR 1040.10 AND 1040.11 EXCEPT FOR DEVIATIONS PURSUANT TO LASER NOTICE NO-50, DATED JULY 26, 2001

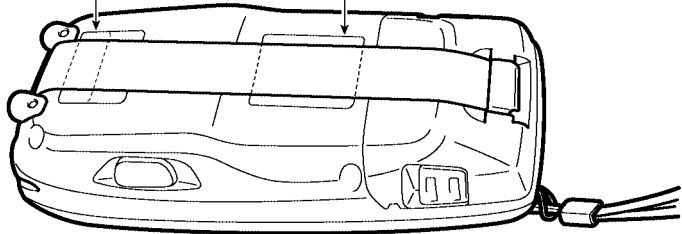

■ Grip style BHT

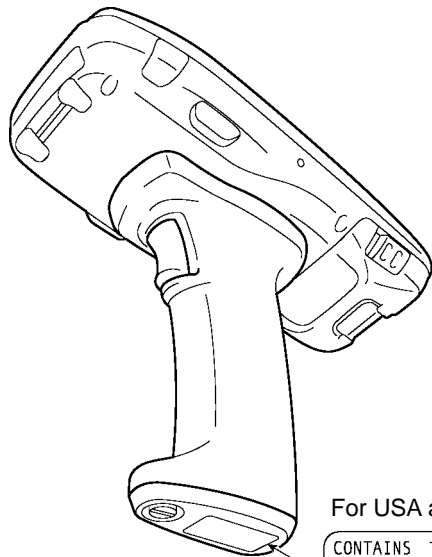

For USA and Canada

CONTAINS - FCC ID : H9PLA4137
 - CANADA : 1549104431A

THIS DEVICE COMPLIES WITH PART 15 OF THE FCC RULES. OPERATION IS SUBJECT TO THE FOLLOWING TWO CONDITIONS: (1) THIS DEVICE MAY NOT CAUSE HARMFUL INTERFERENCE, AND (2) THIS DEVICE MUST ACCEPT ANY INTERFERENCE RECEIVED, INCLUDING INTERFERENCE THAT MAY CAUSE UNDESIRABLE OPERATION. THIS DEVICE COMPLIES WITH RSS-210. THIS CLASS A DIGITAL APPARATUS COMPLIES WITH CANADIAN ICES-001. CET APPAREIL NUMÉRIQUE DE LA CLASSE A EST CONFORME À LA NORME NMB-001 DU CANADA.

Declaration of Conformity (For European Union)

The radio frequency module (Type: LA-4137) that complies with the Directive 99/5/EC(R&TTE) is mounted on this device (BHT-202BW-CE).

A Declaration of Conformity may be obtained from:

<http://www2.symbol.com/doc/>

Preface

Please READ through these operating instructions carefully. It will enable you to operate your BHT-202B-CE/202BW-CE correctly.

The following contents are explained in this guide:

- Handling and operating methods for the BHT-202B-CE/202BW-CE
- Communication
- Error messages
- Specifications
- Handling and operating methods for the optical communication unit CU-200 series

The BHT-202B-CE/202BW-CE models are designed in the same way except for the interface differences shown in the table below. In this manual, operations common for all models are explained unless otherwise stated.

	Wireless Communication
BHT-202B-CE	–
BHT-202BW-CE	•

After you have finished reading the instructions, keep this manual handy for speedy reference.

How this book is organized

This manual is made up of five chapters and appendices.

Chapter 1 Quick Guide

Describes the basic operating method of the BHT and the related notes.

Chapter 2 Getting Started the BHT and System Menu

Summarizes the BHT system configuration and describes the operation including preparation and System Mode (which is required for the efficient use of application programs).

Chapter 3 Communications Operations of the BHT-202B-CE/202BW-CE

Describes the communications operations of the BHT-202B-CE/202BW-CE —the spread spectrum communication (BHT-202BW-CE only), infrared communication, USB interface specifications, connector interface specifications (BHT-202BW-CE), basic communications specifications, communication using Ymodem, and ActiveSync—for data transfer with the host computer or other devices.

Chapter 4 Error Messages

Lists the error messages which will appear on the LCD if some error occurs in the BHT.

Chapter 5 Handling the CU-200 (Option)

Describes the handling procedure of the communication unit CU-200, the interfacing with the host computer, and the charging of the rechargeable battery cartridge.

Appendix A: Specifications

Appendix B: Loading an Optional Compact Flash Card

Appendix C: Quality Assurance Standards

■ Related Publications

BHT-200-CE API Reference Manual

BHT-200-CE Class Library Reference Manual

2D Code Scanner/Barcode Scanner Keyboard Interface with BHT-CE kbifCE User's Guide

■ Screen Indication

The lettering in the screens in this manual is a little different from that in the actual screens. File names used are only for description purpose, so they will not appear if you have not set files having those names.

SAFETY PRECAUTIONS

Be sure to observe all these safety precautions.

- Please READ through this manual carefully. It will enable you to use the BHT and CU correctly.
- Always keep this manual nearby for speedy reference.

Strict observance of these warnings and cautions is a **MUST** for preventing accidents that could result in bodily injury and substantial property damage. Make sure you fully understand all definitions of these terms and symbols given below before you proceed to the text itself.



WARNING

Alerts you to those conditions that could cause serious bodily injury or death if the instructions are not followed correctly.



CAUTION

Alerts you to those conditions that could cause minor bodily injury or substantial property damage if the instructions are not followed correctly.

Meaning of Symbols



A triangle (⚠) with a picture inside alerts you to a warning of danger. Here you see the warning for electrical shock.





A diagonal line through a circle (⊘) alerts you to something you should not do; it may or may not have a picture inside. Here you see a screwdriver inside the circle, meaning that you should not disassemble.







A black circle (●) with a picture inside alerts you to something you **MUST** do. This example shows that you **MUST** unplug the power cord.

! WARNING

Handling the battery cartridge

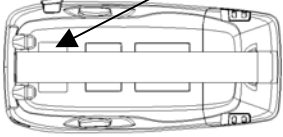



	<ul style="list-style-type: none"> • Never disassemble or heat the battery cartridge, nor put it into fire or water; doing so could cause battery-rupture or leakage of battery fluid, resulting in a fire or bodily injury. • Do not carry or store the battery cartridge together with metallic ball-point pens, necklaces, coins, hairpins, etc. Doing so could short-circuit the terminal pins, causing the batteries to rupture or the battery fluid to leak, resulting in a fire or bodily injury. • Avoid dropping the battery cartridge or letting it undergo any shock or impact. Doing so could cause the batteries to break, generate heat, rupture or burn. • Never charge the rechargeable battery cartridge where any inflammable gases may be emitted; doing so could cause fire.
	<ul style="list-style-type: none"> • Only use the dedicated charger (CU-200, CH-201) for charging the rechargeable battery cartridge. Using a different type of charger could cause battery-rupture or leakage of battery fluid and result in a fire, bodily injury, or serious damage to property.

Handling the BHT

	<ul style="list-style-type: none"> • The BHT uses a laser light for indicating the scanning range. The intensity of the laser light might be too low to inflict bodily injury. However, do not look into the laser beam or view directly with optical instruments. The BHT complies with IEC 60825-1:1993+A2:2001. In accordance with Clause 8 and 9, IEC 60825-1, the following information is provided to the user: <div style="text-align: center;"> <p>LASER RADIATION DO NOT STARE INTO BEAM OR VIEW DIRECTLY WITH OPTICAL INSTRUMENTS CLASS 2M LASER PRODUCT</p>  </div> <div style="display: flex; justify-content: space-around; margin-top: 10px;"> <div style="text-align: center;"> <p>For USA and Canada</p>  </div> <div style="text-align: center;"> <p>For European Union</p>  </div> </div> <p>Caution - Use of controls or adjustments or performance of procedures other than those specified herein may result in hazardous laser light exposure.</p>
	<ul style="list-style-type: none"> • Do not look into the light source through the reading window or point the light source towards the eyes. The light emitted through the reading window is harmful to the eyes. • Do not poke at the eyes with the stylus that comes with the BHT.

WARNING

Handling the CU

 	<ul style="list-style-type: none">• If smoke, abnormal odors or noises come from the CU, immediately unplug the AC adapter from the wall socket or CU and contact your nearest dealer. Failure to do so could cause fire or electrical shock.• If foreign material or water gets into the CU, immediately unplug the AC adapter from the wall socket or CU and contact your nearest dealer. Failure to do so could cause fire or electrical shock.• If you drop the CU so as to damage its housing, immediately unplug the AC adapter from the wall socket or CU and contact your nearest dealer. Failure to do so could cause fire or electrical shock.
	<ul style="list-style-type: none">• Never use the CU for charging anything other than the specified battery cartridges. Doing so could cause heat, battery-rupture, or fire.• Never bring any metals into contact with the output terminals. Doing so could produce a large current through the CU, resulting in heat or fire, as well as damage to the CU.• Never use the CU on the line voltage other than the specified level. Doing so could cause the CU to break or burn.
	<ul style="list-style-type: none">• Use the dedicated AC adapter only. Failure to do so could result in fire.• If the power cord of the AC adapter is damaged (e.g., exposed or broken lead wires), stop using it and contact your nearest dealer. Failure to do so could result in a fire or electrical shock.

CAUTION

Handling the battery cartridge



- Never charge a wet or damp rechargeable battery cartridge. Doing so could cause the batteries to break, generate heat, rupture or burn.

Handling the BHT



- If smoke, abnormal odors or noises come from the BHT, immediately turn off the power, pull out the battery cartridge, and contact your nearest dealer. Failure to do so could cause smoke or fire.
- If foreign material or water gets into the BHT, immediately turn off the power, pull out the battery cartridge, and contact your nearest dealer. Failure to do so could cause smoke or fire.
- If you drop the BHT so as to damage its housing, immediately turn off the power, pull out the battery cartridge, and contact your nearest dealer. Failure to do so could cause smoke or fire.
- Do not use batteries or power sources other than the specified ones; doing so could generate heat or cause malfunction.



Never disassemble



- Never disassemble or modify the BHT; doing so could result in an accident such as break or fire.



- Never put the BHT in places where there are excessively high temperatures, such as inside closed-up automobiles, or in places exposed to direct sunlight. Doing so could affect the housing or parts, resulting in a fire.
- Avoid using the BHT in extremely humid or dusty areas, or where there are drastic temperature changes. Moisture or dust will get into the BHT, resulting in malfunction, fire or electrical shock.
- In environments where static electricity can build into significant charges (e.g., if you wipe off the plastic plate with a dry cloth), do not operate the BHT. Doing so will result in malfunction or machine failure.
- Tap the LCD only with the stylus that comes with the BHT. Using the tip of a pen or any pointed object will result in a damaged or broken LCD.

CAUTION

Handling the CU

	<ul style="list-style-type: none">• Never disassemble or modify the CU; doing so could result in an accident such as fire or malfunction.
	<ul style="list-style-type: none">• Never put the CU in places where there are excessively high temperatures, such as inside closed-up automobiles, or in places exposed to direct sunlight. Doing so could affect the housing or parts, resulting in a fire.• Avoid using the CU in extremely humid or dusty areas, or where there are drastic temperature changes. Moisture or dust will get into the CU, resulting in malfunction, fire or electrical shock.• Never cover or wrap up the CU or AC adapter in a cloth or blanket. Doing so could cause the unit to heat up inside, deforming its housing, resulting in a fire. Always use the CU and AC adapter in a well-ventilated area.• Do not place the CU anywhere where it may be subjected to oily smoke or steam, e.g., near a cooking range or humidifier. Doing so could result in a fire or electrical shock.• Keep the power cord away from any heating equipment. Failure to do so could melt the sheathing, resulting in a fire or electrical shock.• Do not insert or drop foreign materials such as metals or anything inflammable through the openings or vents into the CU. Doing so could result in a fire or electrical shock.
	<ul style="list-style-type: none">• If you are not using the CU for a long time, be sure to unplug the AC adapter from the wall socket for safety. Failure to do so could result in a fire.• When caring for the CU, unplug the AC adapter from the wall socket for safety. Failure to do so could result in an electrical shock.

■ Proper Care of the BHT and CU

Clean the housings, BHT charge terminals, battery cartridge terminals, and CU-200 charge terminals with a dry, soft cloth. Before cleaning, be sure to turn the BHT power off and unplug the AC adapter of the CU.

- Never use benzene, alcohol, or other organic solvents. The housing may be marred or the paint may come off.
- Never rub or strike the liquid crystal display (LCD) with anything hard. The LCD surface will be easily scratched or broken.
- When cleaning the keypad, do not scrub the surface too hard, and do not pull the keys. Doing so may break the keys or cause the keypad to dislocate.
- If the BHT or CU becomes smudged, moisten a soft cloth with neutral detergent and wring it out thoroughly. Wipe the BHT or CU with the cloth and then go over it again with a dry cloth.



Dust or dirt accumulating on the clear plate of the reading window will affect reading performance. If you use the BHT in dusty areas, therefore, periodically check the clear plate of the reading window and clean it if dusty.

- To clean the plate, first blow the dust away with an air brush. Then wipe the plate with a cotton swab or the similar soft one gently.
- If sand or hard particles have accumulated, never rub the plate; doing so will scratch or damage it. Blow the particles away with an air brush or a soft brush.

■ Limited Warranty on Software Products

In no event will DENSO WAVE INCORPORATED be liable for direct, indirect, special, incidental, or consequential damages (including imaginary profits or damages resulting from interruption of operation or loss of business information) resulting from any defect in the software or its documentation or resulting from inability to apply the software or its documentation.

- DENSO WAVE INCORPORATED does not assume any product liability arising out of, or in connection with, the application or use of any product, circuit, or application described herein.
- If it is judged by DENSO WAVE INCORPORATED that malfunction of the product is due to the product having been dropped or subjected to impact, repairs will be made at a reasonable charge even within the warranty period.

■ Intellectual Property Precaution

DENSO WAVE INCORPORATED ("DENSO WAVE") takes reasonable precautions to ensure its products do not infringe upon any patent or other intellectual property rights of other(s), but DENSO WAVE cannot be responsible for any patent or other intellectual property right infringement(s) or violation(s) which arise from (i) the use of DENSO WAVE's product(s) in connection or in combination with other component(s), product(s), data processing system(s) or equipment or software not supplied from DENSO WAVE; (ii) the use of DENSO WAVE's products in a manner for which the same were not intended nor designed; or (iii) any modification of DENSO WAVE's products by other(s) than DENSO WAVE.

Chapter 1 Quick Guide

Chapter 2 Getting Started the BHT and System Menu

**Chapter 3 Communications Operations
of the BHT-202B-CE/202BW-CE**

Chapter 4 Error Messages

Chapter 5 Handling the CU-200 (Option)

Appendices

Chapter 1

Quick Guide

This chapter describes the basic operating method of the BHT and the related notes.

1.1	Reading Bar Codes	2
1.2	Setting and Using the Hand Strap and Stylus	4
1.3	Setting the Backlight	6
1.4	Using the Keypad	7
1.5	Transferring Data	8

1.1 Reading Bar Codes

Turn the BHT on, bring the bar-code reading window to the bar code to be scanned, and press the trigger switch. Pressing the trigger switch halfway emits a laser light to indicate the scanning range and pressing it fully turns on the illumination LED to scan the bar code.

When the BHT has read the bar code successfully, the indicator LED will illuminate in blue.

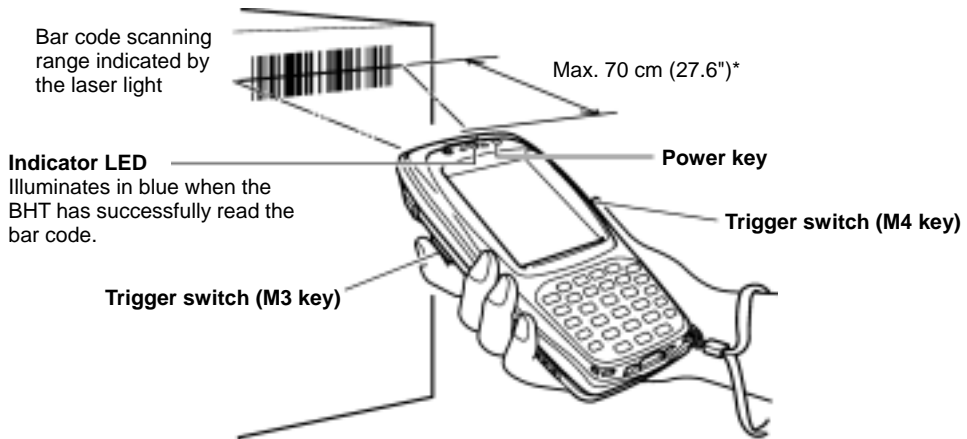

■ Grip style BHT

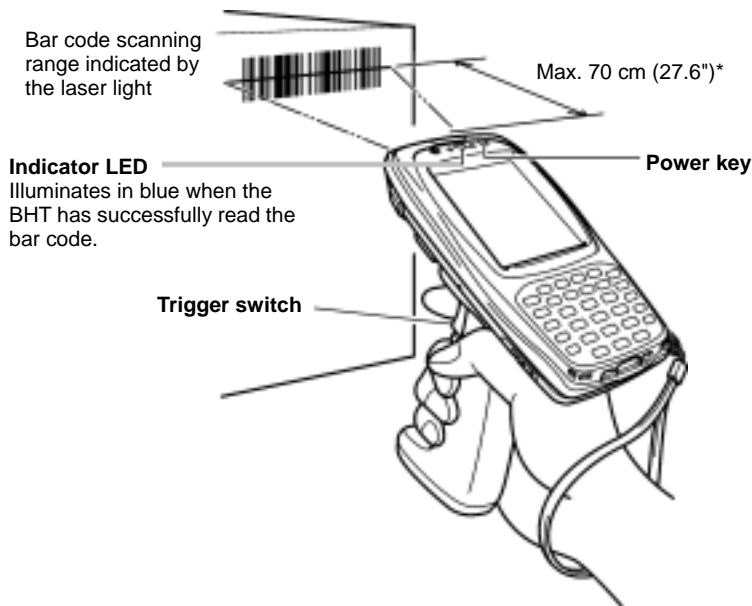

* The BHT can read bar codes at a maximum distance of 70 cm (27.6") from the reading window. (*For details about the scanning conditions, refer to Appendix A.)

- If the BHT fails to read due to specular effects or other factors, change the scanning angle of the reading window or the distance from codes as shown at right, and try it again. (Specular effects occur when the reflection of the light from the bar code becomes excessively strong. This can easily happen when the reflecting surface is polished or covered with vinyl.)
- The laser light indicates the scanning range as a guide. The indicated scanning range will deviate a little bit from the actual one. Keep the BHT so that the laser light comes to almost the center of the bar code height.
- The bar code reading procedure may differ depending upon the application used, so follow the application's manual.

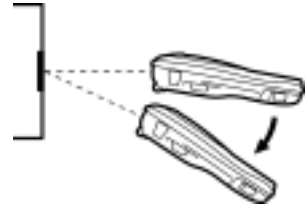

NOTE

- Before reading labels, clean them if stained.
- Avoid using the BHT in direct sunlight. The BHT might fail to read correctly.
- To read bar codes on curved surfaces, apply the bar-code reading window to the center of each bar code at a right angle.
- If you pull the bar-code reading window away from bar codes, the actual scanning range will become narrower than the range covered by the illumination LED.
- Do not use the BHT in the vicinity of radio equipment. The BHT may malfunction.

TIP

- The light intensity of the laser light or illumination LED will vary depending upon the scanning conditions and variation of its elements.
- By using the “KbifCE” utility software, codes read by the BHT can be converted into keyboard data to be transmitted to an application program. The utility software can be downloaded from our web site (<http://www.denso-wave.com>). For further details, refer to “2D Code Scanner/Barcode Scanner Keyboard Interface with BHT-CE kbifCE User's Guide “ that comes with the software.

1.2 Setting and Using the Hand Strap and Stylus

■ Setting the hand strap

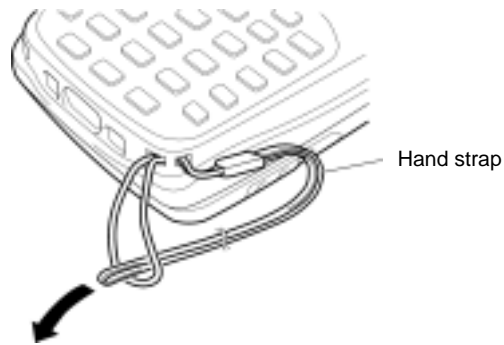

■ Using the hand strap

Put your hand through the hand strap and hold the BHT as shown below. This will prevent you from dropping the BHT accidentally.

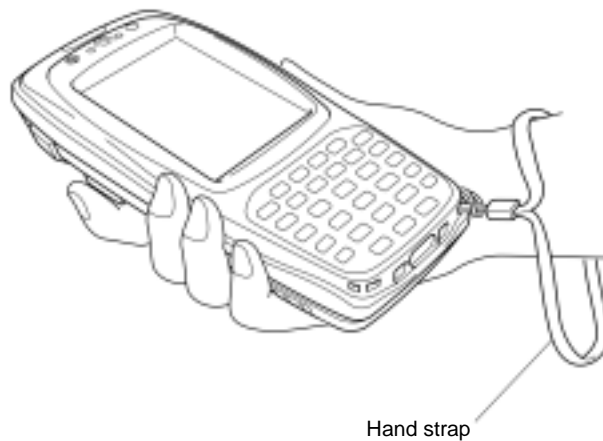

■ Using the stylus

The BHT has a touch screen LCD. With the stylus that comes with the BHT, you can operate keys, menus, and icons displayed on the touch screen.

Before using the touch screen, be sure to set it up. (Refer to Chapter 2, Section 2.3.2, "Setting-up 2: Calibrating the touch screen.")



NOTE

- Always use the stylus to operate the touch screen. Do not use your fingernails or any pointed or hard object or apply a strong pressure or impact to the LCD.
- Before operation, clean the surface of the LCD and the tip of the stylus if dirty. Using dirty ones will scratch the LCD surface or prevent the stylus from sliding smoothly.

■ Operating the touch screen

Action	Description
Tap	Refers to touching the LCD once. (Functionally equivalent to "click" with a mouse on a PC.)
Double-tap	Refers to quickly touching the LCD twice. (Functionally equivalent to "double-click" with a mouse on a PC.)
Drag	Refers to moving the stylus to the object while touching the LCD. (Functionally equivalent to "drag" with a mouse on a PC.)

1.3 Setting the Backlight

Pressing the right-hand trigger switch (**M4** key) with the **SF/ALP** key held down activates or deactivates the backlight function.

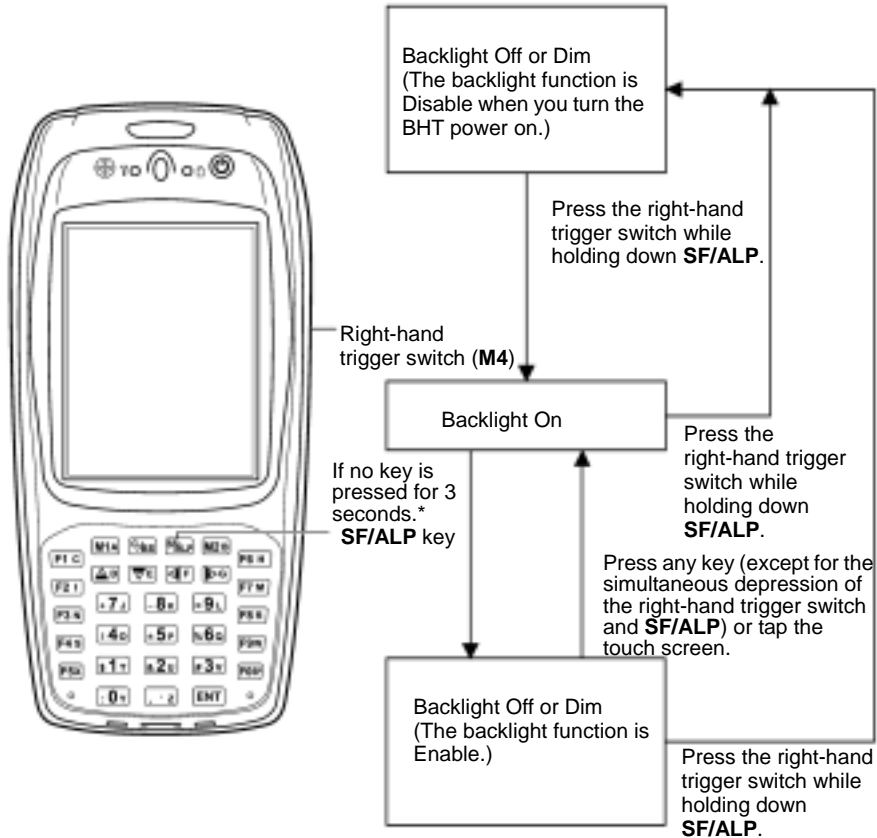

*For one minute if the BHT is placed on the CU.

NOTE In user programs, you can select the key to be used for activating or deactivating the backlight function (instead of the initial setting: combination of **SF/ALP** key and right-hand trigger switch (**M4**)), as well as modifying the on-duration of the backlight before the automatic turning-off.

TIP You can enable or disable the backlight function on the Backlight menu, instead of pressing the backlight function on/off key.

1.4 Using the Keypad

■ Entering Numerical Data

To enter numerical data, use the numerical keys and the **ENT** key.

For example, to enter the number "120," press the **1**, **2** and **0** keys and then press the **ENT** key.

If you type in any wrong value, press the **C/BS (BS)** key and then enter the correct one.

■ Entering alphabetic characters

The alphabet entry procedure differs depending upon the keypad type.

30-key pad

Holding down the **SF/ALP** key only for the specified period (1.5 seconds) or more switches the BHT to the alphabet entry mode. You can use the numeric keys and function keys to type in alphabet letters printed on those keys in light blue. To switch back to the numeric entry mode, hold down the **SF/ALP** key again.

26-key pad

Pressing the **ALP** key switches the BHT to the alphabet entry mode. You can type in alphabet letters using the numeric keys in the same way as you use a cellular phone. If you press a numeric key, the alphabet assigned to that key will appear in the ALP window (see Chapter 2, Section 2.2.2 "Status Indicators on the LCD." Pressing the **ENT** key establishes the alphabet displayed. To switch back to the numeric entry mode, press the **ALP** key again.

For both the 30-key and 26-key pad types, you can switch between the numeric and alphabet entry modes also in user programs. For programming the mode switching, refer to the "BHT-200-CE API Reference Manual" or "BHT-200-CE Class Library Reference Manual."

■ Using the software keyboard

You can display or hide the software keyboard by tapping the software keyboard status icon on the task tray.

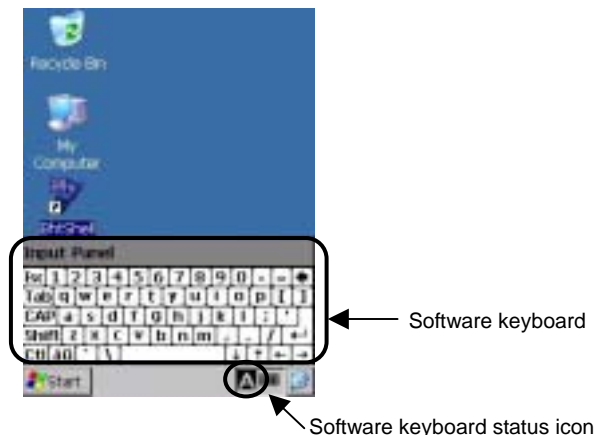

Just as from the hardware keyboard, you can enter data from the software keyboard, by tapping keys on it.

1.5 Transferring Data

■ Using radio link (BHT-202BW-CE only)

Using radio waves, the BHT-202BW-CE may transfer data to an access point in a spread spectrum communications system.

NOTE

If there are too many communications errors, first make sure that the BHT-202BW-CE points directly at an access point.

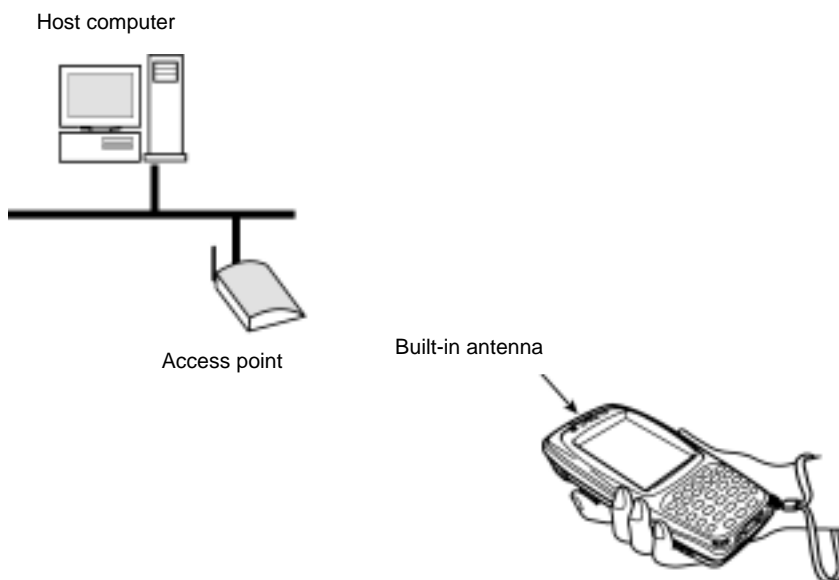

For data transfer using radio link, it is necessary to configure a wireless local area network (wireless LAN) connecting the BHT-202BW-CE and access points.

■ Using infrared link

Using infrared rays, the BHT may transfer data directly to the host computer equipped with an IrDA interface port and other IrDA-compliant devices.

NOTE

- Make sure that there is no obstruction in the light path between the BHT and any target stations. In infrared communication, you need to keep the BHT and any target stations within the effective infrared radiation range, usually 15 cm (5.9").
- Shield the IrDA interface from direct sunlight, ambient intense lighting (inverter-driven fluorescent lighting, in particular), and other potential sources of infrared radiation. Sources to watch out for include remote control units for television sets and the like.

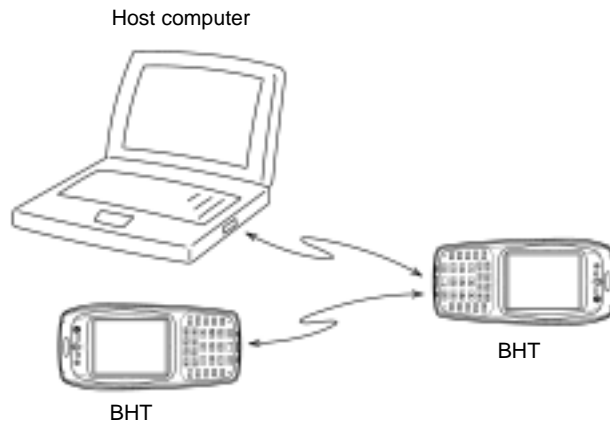

For a host computer having no IrDA interface port, use the optical communication unit CU-200 (option) connected to the host via an RS-232C interface cable. Put the BHT on the CU-200 as shown below.

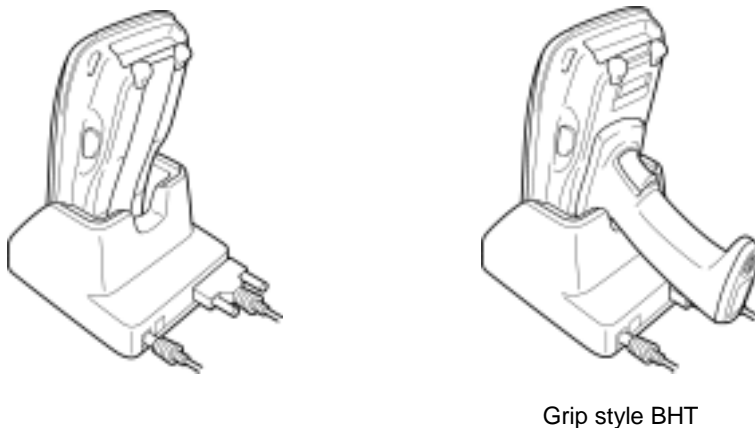

■ Using USB interface

Using a USB interface cable, the USB interface ports of the BHT and a host computer can be connected, allowing data to be transferred to the host computer.

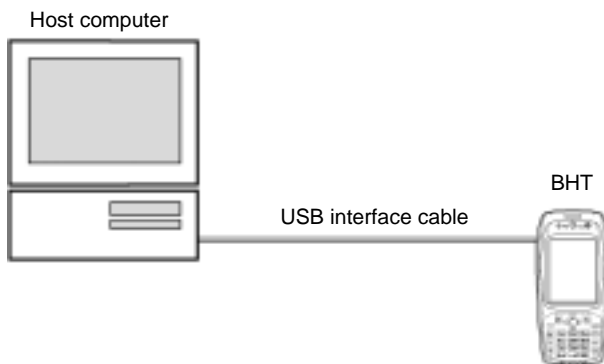

■ Using connector interface

Using a connector interface cable, the RS-232C interface of a host computer and the connector interface port of the BHT can be connected allowing data to be transferred to the host computer.

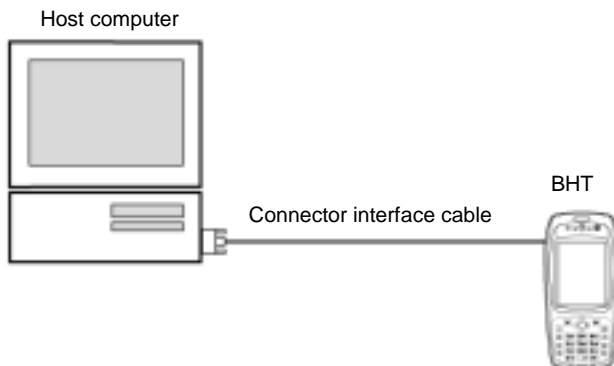

Chapter 2

Getting Started the BHT and System Menu

This chapter summarizes the BHT system configuration and describes the operation including preparation and System Menu (which is required for the efficient use of application programs).

2.1	BHT System Configuration	12
2.2	Components	16
2.2.1	Names and Functions	16
2.2.2	Status Indicators on the LCD	20
2.2.3	Notes for Using the BHT	22
2.3	Preparation	23
2.3.1	Setting-up 1: Loading the battery cartridge	23
2.3.2	Setting-up 2: Calibrating the touch screen	28
2.3.3	Battery Replacement Notes	29
2.3.4	BHT Turning-off Notes	30
[1]	"Shutdown in progress" message	30
[2]	Backing up the Registry	31
2.3.5	Warm and Cold Booting	32
2.4	Replacement of the Backup Battery	34
2.4.1	Replacing the Backup Battery	35
2.4.2	Resetting the Discharge Counter	41
2.5	Operating in System Menu	42
2.5.1	Desktop	42
2.5.2	Start Menu	46
2.5.3	Operating in System Menu	57
2.5.4	Detailed Description of the Functions in System Menu	60
[1]	Execute Program	60
[2]	Communication Menu	61
[3]	System Properties Menu	74
[4]	Test Menu	94
[5]	Explorer	106
[6]	System Information	106
2.6	Wireless Zero Configuration (WZC)	107

2.1 BHT System Configuration

The BHT barcode data collection system requires the following hardware as well as the BHT Bar Code Handy Terminal (which reads bar codes and accepts keypad entry), depending upon the intended system configuration.

- Host computer: Allows you to edit, manage and download user programs and data, as well as downloading system programs.

For host computers having no IrDA interface ports, the optional CU-200 optical communication unit and RS-232C interface cable (for CU-201) or USB cable (for CU-221) are available.

- CU-200 (option): Exchanges programs and data with the BHT via the IrDA interface and with the host computer via the RS-232C interface.
- RS-232C interface cable (option): Connects the CU-200 and the host computer.
- USB interface cable (option): Connects the CU-221 and the host computer.

Connector interface cable/USB cable connection between the BHT and host computer is also possible.

As an application development tool, Microsoft eMbedded Visual C++ (Service Pack 4 or later), Microsoft Visual Studio .NET or Microsoft Visual Studio .NET 2003 should be used.

System Configuration

Communications System

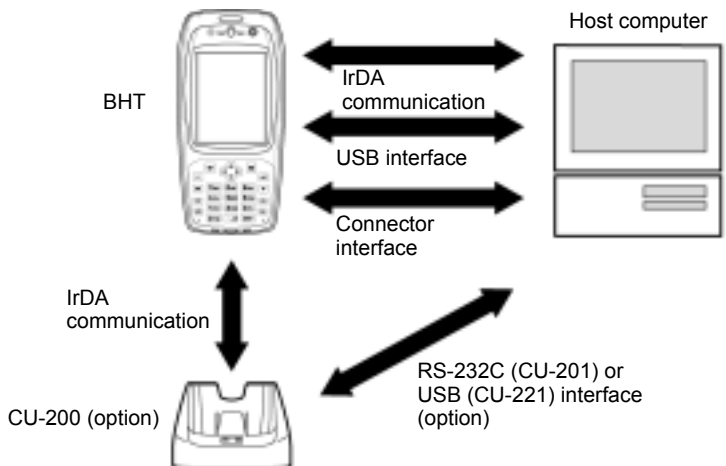

In addition, the BHT-202BW-CE may operate in a radio communications system (spread spectrum communication) by connecting with access points by a wireless local area network (wireless LAN).

- Access point: Wireless communications base unit for the BHT

Radio Communications System (available with the BHT-202BW-CE only)

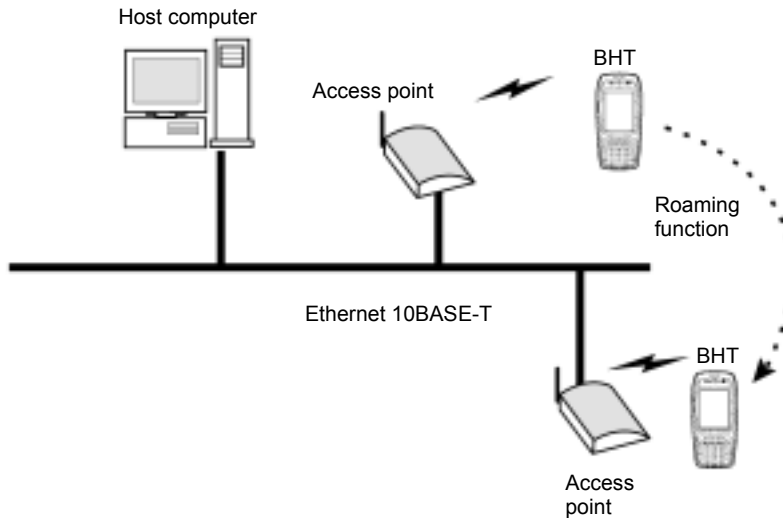

■ **CU-201 and RS-232C Interface Cable (option)**

The CU-201 is an IrDA-compliant communications unit which is required when your host computer is not equipped with an IrDA interface port. The CU-200 exchanges data and programs with the BHT optically, and with the host computer via the RS-232C interface cable.

■ **CU-221 and USB Interface Cable (option)**

The CU-221 is an IrDA-compliant communications unit and is required when the host computer is not equipped with an IrDA interface port. The CU-200 exchanges data and programs with the BHT optically, and with the host computer via the USB interface cable.

BHT Operating System (OS)

Microsoft Windows CE .NET 5.0

Application Program Development Environment

■ PC for application development

Item	Description
OS	Microsoft Windows 2000 Professional Service Pack 2 or later, Microsoft Windows 2000 Server Service Pack 2 or later, or Microsoft Windows XP Professional
CPU	Pentium-II class processor, 450 MHz or faster
RAM	For Microsoft Windows 2000 Professional Service Pack 2 or Microsoft Windows XP Professional: 96 MB or more (128 MB or more recommended) ----- For Microsoft Windows 2000 Server Service Pack 2: 192 MB or more (256 MB or more recommended)
HDD	200 MB or more hard disk space
Display	Monitor with 800 x 600 resolution or larger

■ Application Development Tool

Microsoft eMbedded Visual C++ 4.0 Service Pack 4 or later, Microsoft Visual Studio .NET or Microsoft Visual Studio .NET 2003

You can download Microsoft eMbedded Visual Tools 4.0 and Service Pack 4 from the Microsoft Web site at:

(Microsoft eMbedded Visual C++ 4.0)

<http://www.microsoft.com/downloads/details.aspx?displaylang=en&FamilyID=1dacdb3d-50d1-41b2-a107-fa75ae960856>

(Service Pack 4)

<http://www.microsoft.com/downloads/details.aspx?displaylang=en&FamilyID=4A4ED1F4-91D3-4DBE-986E-A812984318E5>

APIs available for application development tools are:

- Win32API
- Microsoft Foundation Class (MFC)
- Dedicated APIs (for device control or data entry from the BHT)

When using Microsoft Visual Studio .NET or Microsoft Visual Studio .NET 2003, refer to the "BHT-200-CE Class Library Reference Manual."

■ Software Development Kit

BHT-200 Software Development Kit named "BHT200_XXXXXX.msi" (XXXXXX: version)

- This is a library to be embedded into application development tools for developing applications for the BHT-202BW-CE.
- For details about the BHT-200 Software Development Kit, refer to the "BHT-200-CE API Reference Manual" or "BHT-200-CE Class Library Reference Manual."

2.2 Components

2.2.1 Names and Functions

* Provided on the BHT-202BW-CE

Synchronization LED*
Flashes during wireless communication.

Built-in antenna*
Do not cover this antenna section with metal-evaporated tape or by hand. Doing so may result in communications failures.

**Interface port:
USB interface port
and connector
interface port**

**Trigger switch
(M3 key)**
Press this switch to start bar code reading.
• Press this halfway to emit a laser light.
• Press this fully to scan a bar code.

Reset button

Indicator LED
Illuminates in blue when the BHT has successfully read a bar code.

Charge LED
Illuminates in red during charging and turns green at completion of charging.

Touch screen LCD (liquid crystal display)
Shows the characters and graphic patterns. You may directly tap the screen with the stylus for data entry.

Trigger switch (M4 key)
Press this switch to start bar code reading.
• Press this halfway to emit a laser light.
• Press this fully to scan a bar code.

Hand strap
Be sure to put your hand through this strap to prevent you from dropping the BHT accidentally.

IrDA interface port
Used to exchange data/programs with the host computer via its integrated IR port or via the optical communication unit CU-200.

Reading window

Hand belt

Compact Flash card slot
Insert an optional Compact Flash card into this memory extension slot.

Rechargeable battery cartridge
Main power source of the BHT.

Release button

Stylus

Release button
Slide this button to open the battery cartridge cover.

Battery cartridge cover
Remove this cover to replace the battery cartridge.

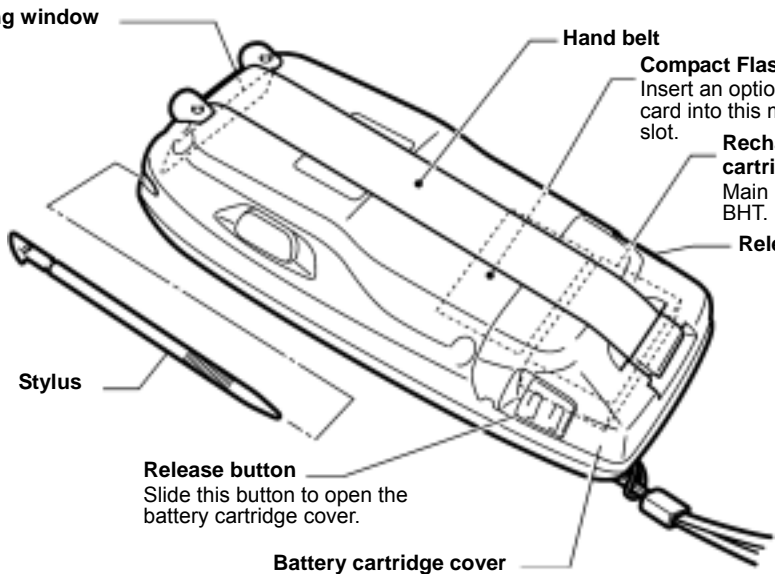
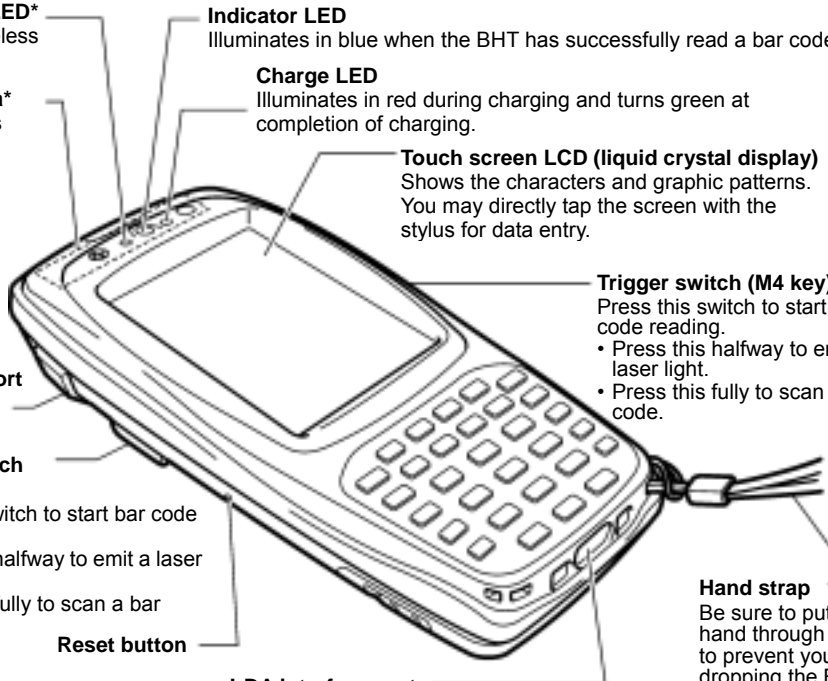

■ Grip style BHT

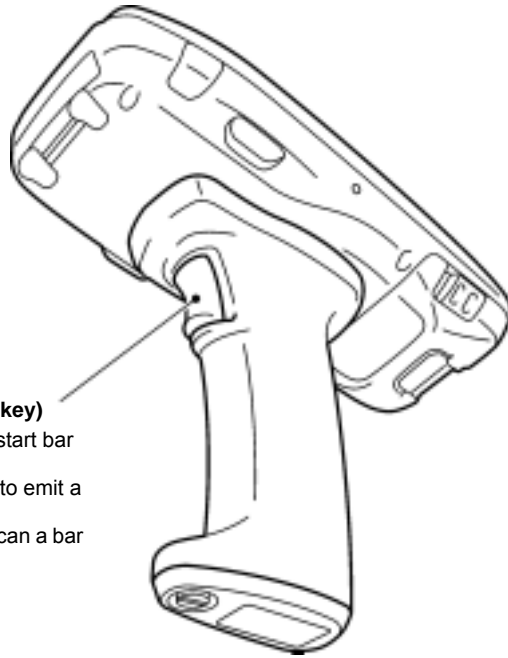

Trigger switch (M5 key)

Press this switch to start bar code reading.

- Press this halfway to emit a laser light.
- Press this fully to scan a bar code.

The functions of the keys may be set by user programs. Shown below is a set of sample functions.

30-key pad

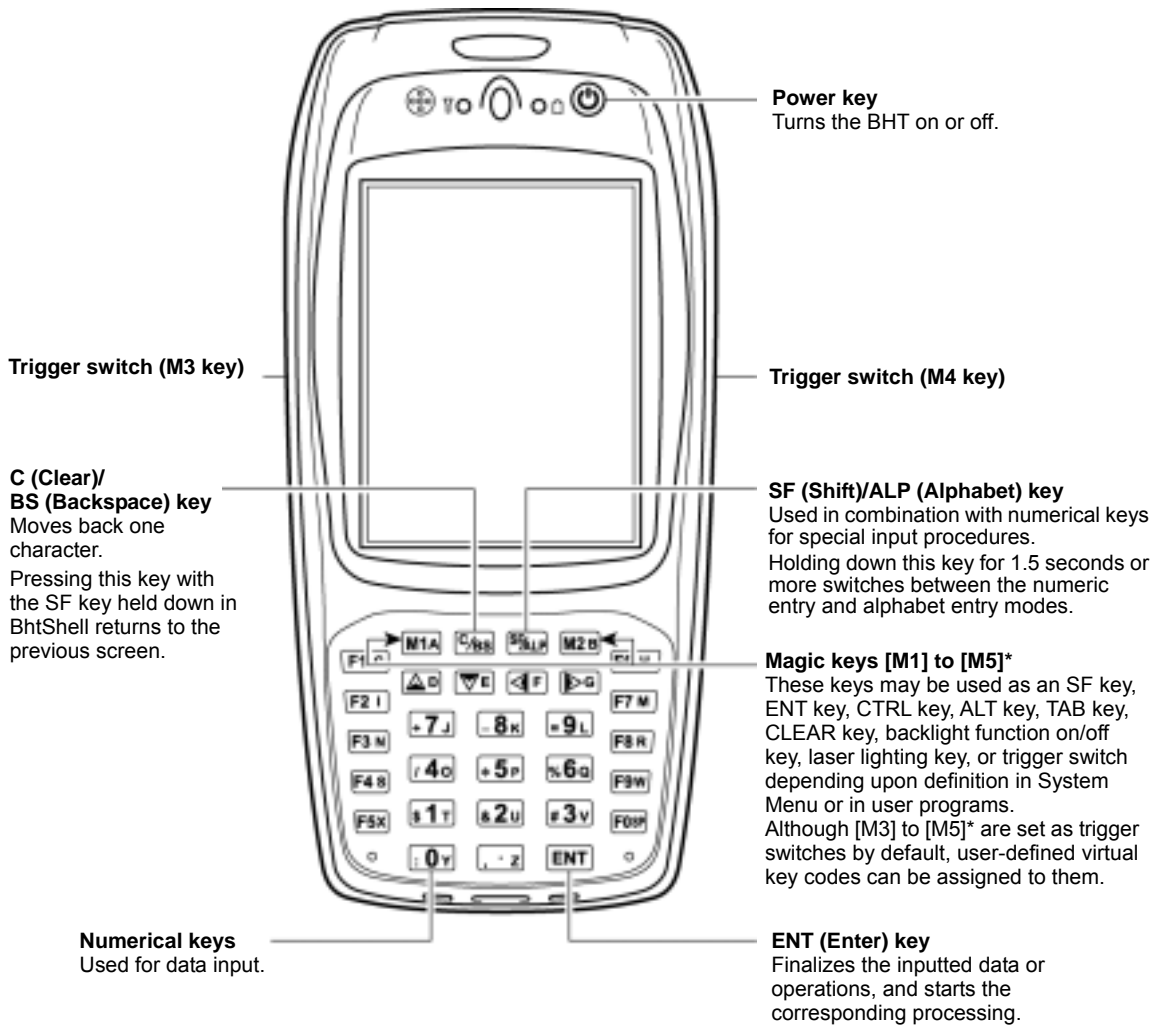

* Provided on the Grip style BHT

26-key pad

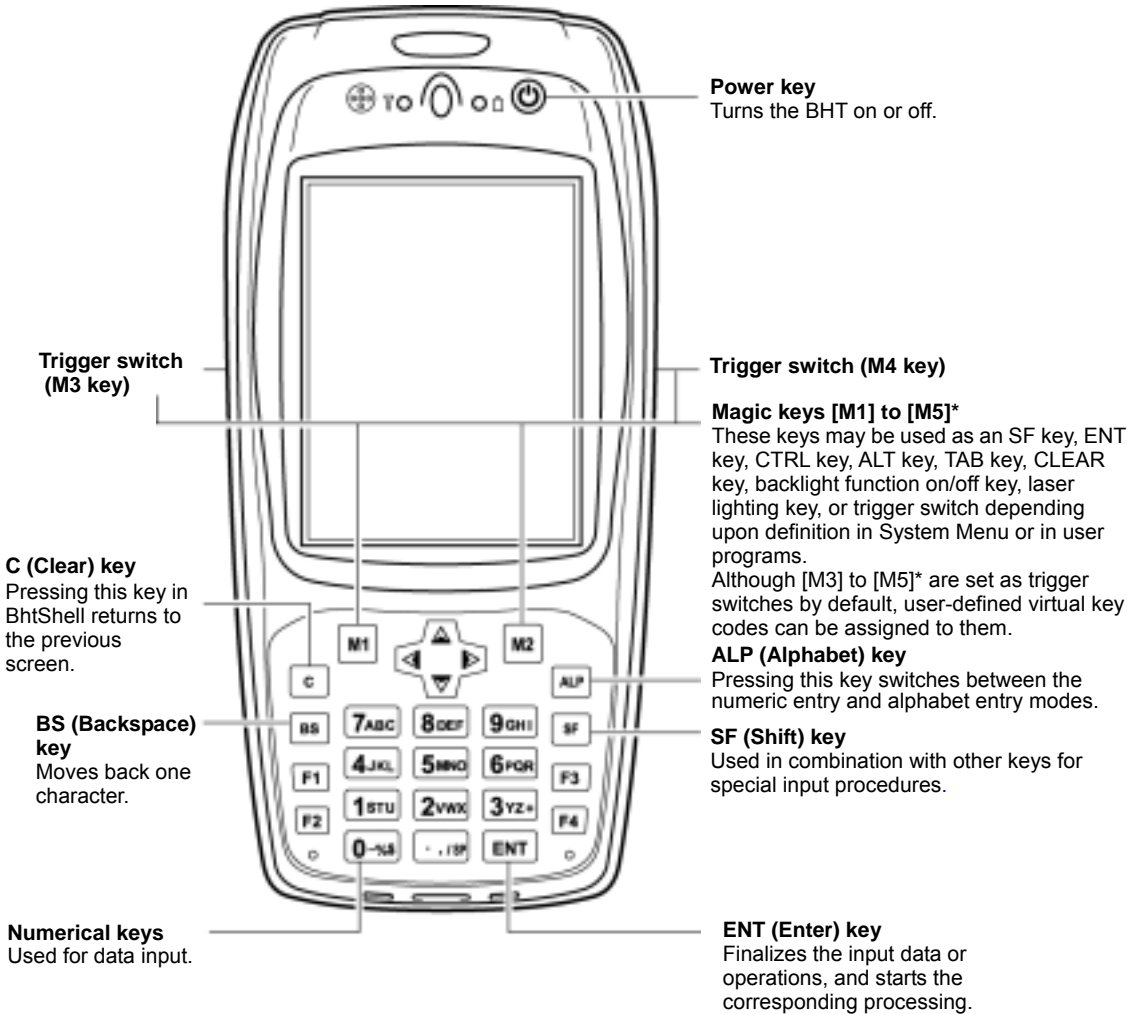

* Provided on the Grip style BHT

2.2.2 Status Indicators on the LCD

Windows desktop on 30-key pad type

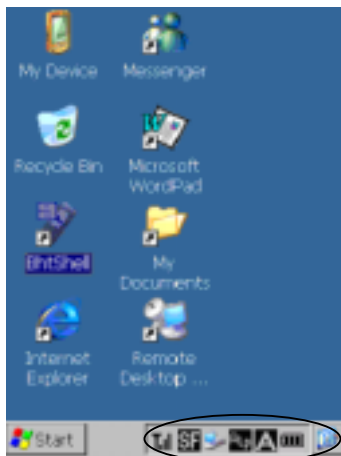

Status indicators

Windows desktop on 26-key pad type

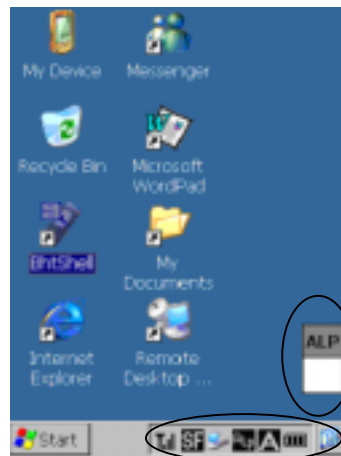

Status indicators



Battery voltage level

Shows the current battery voltage level.

 Displays when the voltage level is high.

 Displays when the voltage level is low.

The grip style BHT shows two icons as shown below. The upper one is for the battery cartridge loaded in the BHT body and the lower one for that in the grip.

 (Voltage level in the BHT body)
 (Voltage level in the grip)

TIP The displayed battery level shows the terminal voltage of the battery cartridge, not how much power is left.

The battery voltage level varies depending upon the operation of the BHT, so the displayed level also may vary.

Software keyboard display/hidden

Shows whether the software keyboard is displayed or hidden.

(Tapping this icon toggles the software keyboard on and off.)

 Displays when the software keyboard is displayed.

 Displays when the software keyboard is hidden.

Synchronization state (Provided on the BHT-202BW-CE)

Displays the open state of the wireless device and the radio field intensity.

 Displays when the wireless device is open.

 Shows the radio field intensity with the number of bars.

 The radio field intensity icons (, , and ) indicate that the radio link is established but do not assure you that there will be few communications errors.

Wireless Zero Configuration (Provided on the BHT-202BW-CE)

 Indicates that the Wireless Zero Configuration (WZC) radio is connected to a wireless network.

 Indicates that the Wireless Zero Configuration (WZC) radio is not connected to a wireless network.

Keypad shift state

 Displays when the keypad is shifted.

ActiveSync

 Displays when the BHT is linked with the PC via the IrDA, USB or etc. interface using Microsoft ActiveSync.

Alphabet input state

 Displays when the alphabet input function is activated.
(Pressing the **SF/ALP (ALP)** key switches between the numeric entry and alphabet entry modes.)

 The ALP window appears only on the 26-key pad type when the alphabet input function is activated. Pressing any numeric key displays the alphabet letter assigned to that key in this ALP window.

Desktop display

 Tapping this icon when an application program is running switches the screen to the desktop display. Tapping it again returns to the application execution screen.

Standby state

 Appears when the CPU comes to be on standby.

(This icon does not appear by default. To display it, you need to change the setting in System Menu or in user programs. For the setting procedure in System Menu, refer to Section 2.5.4, "[3.7] Status Display." For that in user programs, refer to the "BHT-200-CE API Reference Manual" or "BHT-200-CE Class Library Reference Manual.")

Caps Lock state

 Appears when the Caps Lock switch is pressed on the software keyboard.

2.2.3 Notes for Using the BHT

■ Windows desktop on the LCD

The Windows desktop shown in this manual may be a little different from that in the actual screens on the LCD.

(Windows desktop sample)

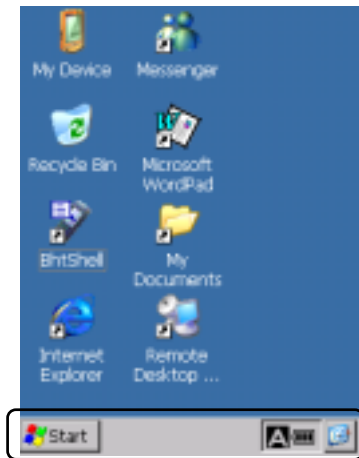

This task tray also may be a little different from that in the actual screen.

■ No refreshing of the LCD screen when on standby

To minimize the power consumption, the BHT automatically switches to the standby mode after it has not been operated for the specified period*.

In the standby mode, the LCD is not refreshed so that icons on the task bar and task tray may not be displayed or refreshed or that the calendar clock may not show the correct date or time.

* The default is one second. The period can be changed in user programs. For details, refer to the "BHT-200-CE API Reference Manual" or "BHT-200-CE Class Library Reference Manual."

■ Opening the wireless communications device

To minimize the power consumption, the wireless communications device in the BHT is not working in regular operation.

To make the BHT ready for wireless communication, you need to open the wireless communications device with the RF Open/Close switches in System Menu or by coding in user programs.

For the opening/closing procedure with the RF Open/Close switches in System Menu, refer to Section 2.5.4, "[3.8] Radio Frequency, ■ Displaying the wireless module version and opening/closing the RF device."

For coding in user programs, refer to the "BHT-200-CE API Reference Manual" or "BHT-200-CE Class Library Reference Manual."

2.3 Preparation

2.3.1 Setting-up 1: Loading the battery cartridge

Before the first use of the BHT, be sure to load the battery cartridge as shown below. The battery cartridge is not loaded in the BHT when shipped from the factory.

■ Into the BHT body

- (1) Turn the BHT upside down.
- (2) Slide the release buttons in the direction shown below and remove the battery cartridge cover.
- (3) Push the battery cartridge into the BHT.

(To remove it, first make sure that the BHT is turned off. Slide the release buttons, remove the battery cartridge cover, and pull up the battery pull strap.)

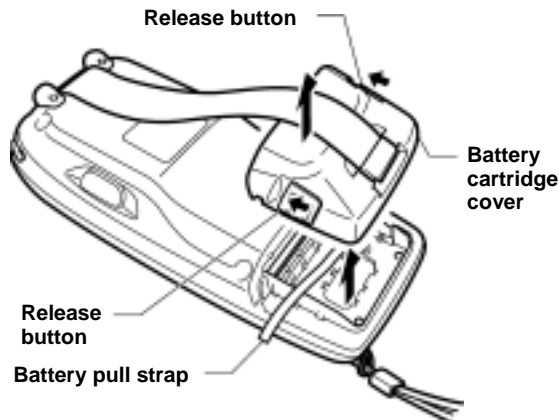

- (4) Set the battery cartridge cover back into place and slide the release buttons to the original position.
- (5) Place the BHT on the CU-200 to charge the rechargeable battery cartridge. (Refer to Section 5.5.)

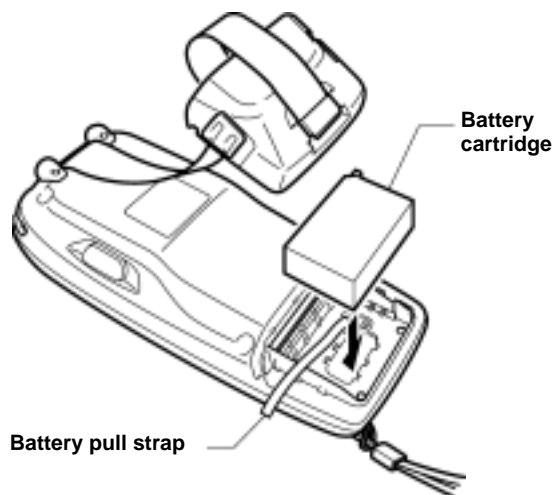

■ Into the grip

(1) Take the bottom cover off the grip by removing the screw.

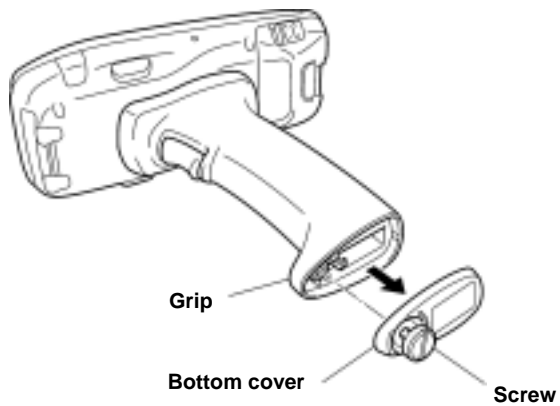

(2) Pull the lock in the direction of the arrow and insert the battery cartridge into the grip with the boss facing as shown below.

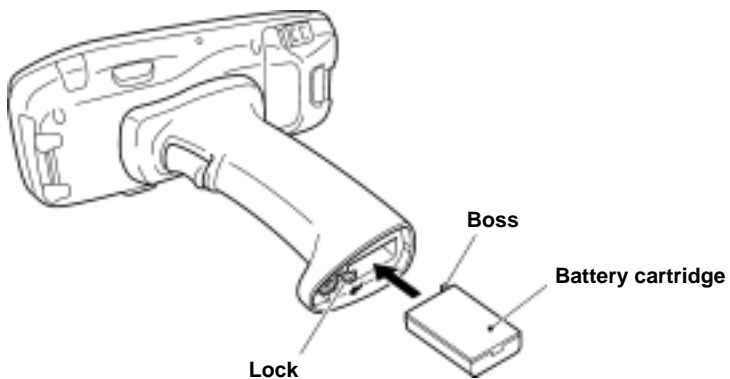

(3) Secure the bottom cover to the grip with the screw.

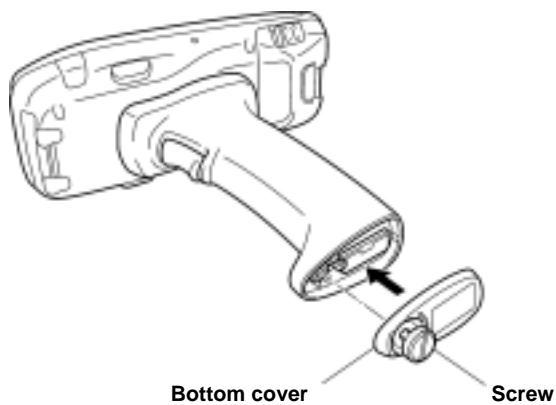

 **WARNING**

- Never disassemble or heat the battery cartridge, nor put it into fire or water; doing so could cause battery-rupture or leakage of battery fluid, resulting in a fire or bodily injury.
- Do not carry or store the battery cartridge together with metallic ball-point pens, necklaces, coins, hairpins, etc.
Doing so could short-circuit the terminal pins, causing the batteries to rupture or the battery fluid to leak, resulting in a fire or bodily injury.
- Avoid dropping the battery cartridge or letting it undergo any shock or impact.
Doing so could cause the batteries to break, generate heat, rupture or burn.
- Never charge the rechargeable battery cartridge where any inflammable gases may be emitted; doing so could cause fire.

 **CAUTION**

- Do not use batteries or power sources other than the specified ones; doing so could generate heat or cause malfunction.

NOTE

- The BHT has an integrated backup power source which backs up the memory and calendar clock in the BHT when no battery cartridge is loaded or the voltage level of the battery cartridge drops below the specified level. The backup power source is automatically charged by the battery cartridge.

When you first load the battery cartridge after purchase or you load it after leaving the BHT unused for a long time, do not remove the battery cartridge for approx. 48 hours after that loading. This is for charging the memory backup source integrated in the BHT.

- Avoid storing the rechargeable battery cartridge in a hot place (50°C, 122°F or higher). The battery capacity may be decreased.
- Do not touch the charge terminals of the rechargeable battery cartridge or stain those terminals. Doing so could result in a charging failure.

■ Battery Voltage Level on the Status Indicator Line

The battery voltage level is always displayed on the status indicator line.
(For details, refer to Section 2.2.2 "Status Indicators on the LCD.")

■ Low Battery Indication

Low battery warning

If the battery output voltage drops below a specified lower level limit when the BHT is in operation, the BHT displays the following message for approx. 2 seconds and beeps three times. After that, it will resume previous regular operation.

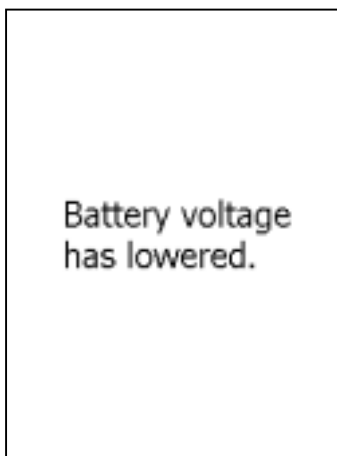

Solution: The battery cartridge will need to be recharged before long. Recharge or replace the battery cartridge as soon as possible.

Shutdown due to low battery

If you continue to use the BHT without recharge or battery replacement after the message above appears, the battery output level lowers to the extent the BHT can no longer operate. The BHT displays the following message, beeps five times, and then turns itself off. Depending upon the battery level, the message may not appear or the beeper may not sound five times.

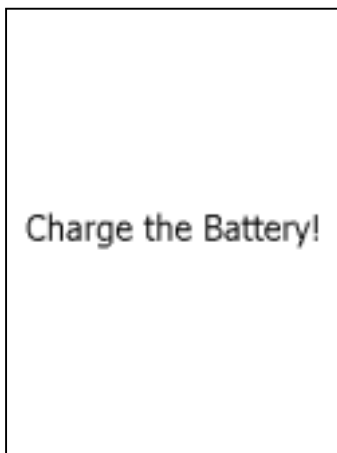

Solution: Recharge or replace the battery cartridge.

Grip style BHT

As long as the voltage level of either one of battery cartridges loaded in the BHT body and grip is higher than the specified level, no low battery messages will appear. If any low battery message appears, therefore, you need to replace both battery cartridges. Even if you only have one fully-charged replacement battery cartridge on hand, remove both batteries.

NOTE

- You may charge the rechargeable battery cartridge with the optional CU-200 communication unit or optional CH-201 charger. For the charging procedure using the CU-200, refer to Chapter 5. For that using the CH-201, refer to the "CH-201 User's Manual."
- If the "Charge the battery!" message appears after the BHT undergoes any shock or impact, turn the power off and on and then check the battery output level. The battery may not have run out.

WARNING



- Only use the dedicated charger (CU-200 or CH-201) for charging the rechargeable battery cartridge.
Using a different type of charger could cause battery-rupture or leakage of battery fluid and result in a fire, bodily injury, or serious damage to property.

CAUTION



- Never charge a wet or damp rechargeable battery cartridge.
Doing so could cause the batteries to break, generate heat, rupture or burn.

2.3.2 Setting-up 2: Calibrating the touch screen

Press the **power** key to turn on the BHT.

The calibration screen appears, so follow the on-screen instructions. If nothing appears, first perform a "cold boot" (refer to Section 2.3.5).



The "+" appears first at the center of the screen as shown at left.

Tap the center of the "+" with the stylus for one second, and the "+" moves to the upper left. Tap its center, and it moves to the bottom left.

This way, tapping the center of the "+" moves it, starting from the center of the screen to the upper left, bottom left, bottom right and upper right in this sequence.

NOTE During calibration, the **power** key is disabled. After completing the calibration, press the **power** key.

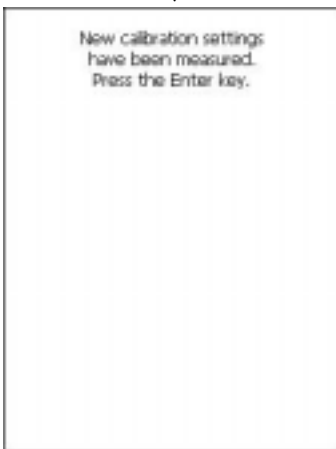

After completion of the above calibration, press the **ENT** key or tap the screen. The calendar clock setup screen will appear as shown below at left.



Set the date, time, and time zone. Then tap the **OK** button.

2.3.3 Battery Replacement Notes

■ When is battery replacement needed?

If the "Charge the battery!" appears on the LCD, replace the battery cartridge with a fully charged one.

If you leave the BHT without replacing the battery cartridge, then the integrated calendar clock or data will no longer be backed up so that the calendar clock may stop or the data may be lost.

Grip style BHT

If "Charge the battery!" appears on the LCD when battery cartridges are loaded in both the BHT body and grip, replace both battery cartridges. (As long as the voltage level of either one of battery cartridges is higher than the specified level, this warning message will not appear.) Always remove both battery cartridges, even if you only have one fully-charged replacement battery cartridge on hand.

NOTE

- Replace the battery cartridge quickly.
- Be sure to turn the BHT off before battery replacement.
- Load a charged battery cartridge within 3 minutes after the removal to avoid data loss.
- After battery replacement, turn the BHT on and check its operation.
- If you leave the BHT with no battery cartridge loaded for a long time, the contents of the memory may no longer be backed up so that the data stored in the BHT may be lost. It is recommended that important data be saved into the FLASH folder or uploaded to the host computer.
- The battery cartridge will gradually deteriorate during the repeated cycles of charging and discharging due to its properties. When the battery operation period becomes shortened due to its deterioration even if it has been charged for the specified hours, replace the battery cartridge with a new one.
- Use only DENSO WAVE-authorized battery cartridges and chargers.
- Never dispose of battery cartridges into a fire. They should be recycled properly. Do not throw them in a trash.
- When disposing of the battery cartridge, cover the terminal pins with vinyl tape to prevent short-circuit.

2.3.4 BHT Turning-off Notes

[1] "Shutdown in progress" message

If you press the **power** key to turn off the BHT, the BHT displays the following message and starts preparation for shutdown.

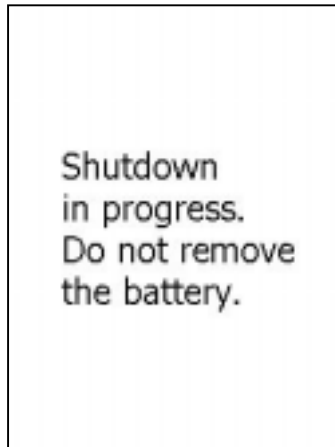

When the above message is displayed, do not remove the battery cartridge.

If you do so, the data stored in the BHT may be lost.

[2] Backing up the Registry

The Registry is the part of Windows CE that stores setup information required for operating the BHT.

■ Backing-up the Registry

When the BHT is on, pressing the power key with the **SF/ALP (SF)** key held down displays the screen shown at right and starts backing up the Registry.

Do not remove the battery cartridge until the backup operation is completed and the message disappears.

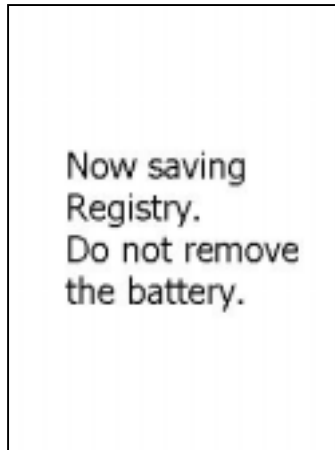

■ Restoring the Registry

If the Registry is lost, the OS automatically restores it.

If the OS fails to restore it (since the Registry has not been backed up), the following error message appears.

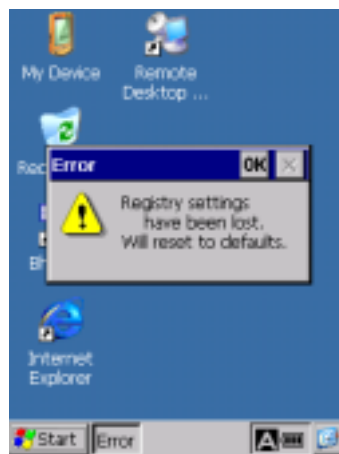

To make the Registry revert to the default, initialize the memory including the Registry. Refer to Section 2.5.4, "[3.4] File System, ■ Initializing the memory including the Registry."

2.3.5 Warm and Cold Booting

■ Warm-booting the BHT

In any of the following cases, warm-boot the BHT:

- The BHT makes no response to entry from the touch screen or keys.
- The programs in the BHT malfunction due to any problems.

NOTE Warm-booting the BHT will not erase data stored in the RAM, but it will erase data being edited and not be saved.

Warm booting procedure

When the BHT power is on, press the reset button with the stylus.

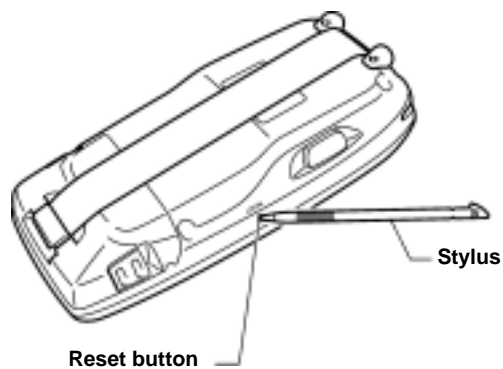

■ Cold-booting the BHT

If a problem persists even after warm-booting the BHT, cold-boot the BHT.



Cold-booting the BHT will erase all data stored in the RAM. It is recommended that important data be saved into the FLASH folder or uploaded to the host computer.

Cold booting procedure

Turn the BHT off. While holding down the reset button with the stylus, press the **power** key and then release them. Press the **power** key again, and the BHT cold-boots.

■ Contents of the memory after warm-/cold-booting the BHT

	After warm booting	After cold booting
Data in the FLASH folder	Retained	Retained
Data in other folders	Retained	Erased
Contents of the Registry	Retained	Erased*
Data being edited	Erased	Erased

* If the Registry has been backed up, the backup will apply. For the backup procedure, refer to Section 2.3.4, "[2] Backing up the Registry."

■ Application program to run automatically at warm-/cold-boot

If any execution program file (XXXXXX.exe) is stored in the FLASH\StartUp folder, warm- or cold-booting the BHT automatically runs that program file.

2.4 Replacement of the Backup Battery

If the following warning message appears on the LCD, you need to replace the backup battery (refer to Section 2.4.1).

NOTE If you remove the backup battery, the contents of the memory may no longer be backed up so that the data stored in the BHT may be lost. It is recommended that important data be saved into the FLASH folder or uploaded to the host computer.

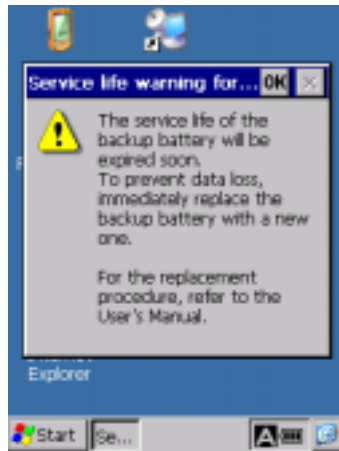

This warning message appears each time the backup battery is fully discharged after 200 times of full discharges.

Even if this warning message appears, you can continue operation by tapping the **OK** button in the top right corner of the message window.

NOTE Each time the backup battery is fully discharged, the internal discharge counter automatically increments by one; however, replacing the backup battery does not reset the counter to zero automatically. You need to reset the discharge counter (refer to Section 2.4.2).

When the BHT is shipped from the factory, the discharge counter is reset to zero.

2.4.1 Replacing the Backup Battery

NOTE Before proceeding to the replacement procedure below, it is recommended that you save important data into the FLASH folder or upload it to the host computer.

- (1) Turn the BHT upside down.
- (2) Slide the right and left release buttons in the direction of the arrows to remove the battery cartridge cover.

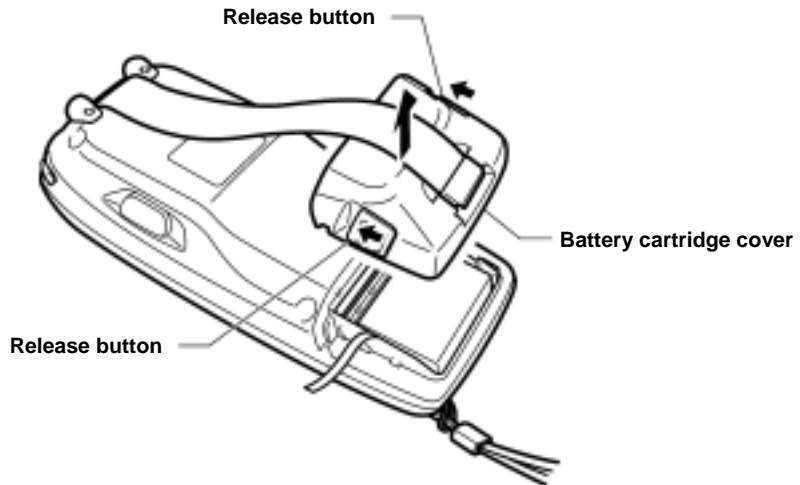

- (3) Pull up the battery pull strap to remove the battery cartridge.

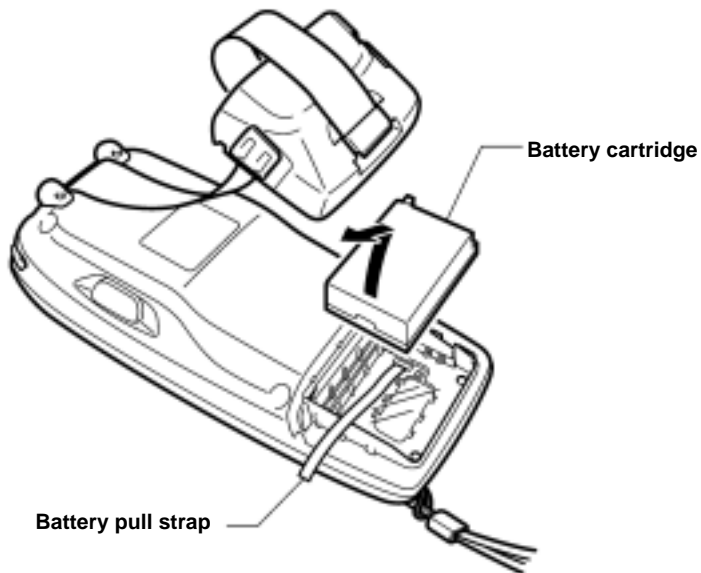

(4) Pull the lock of the inside cover to the right and towards you to release it.

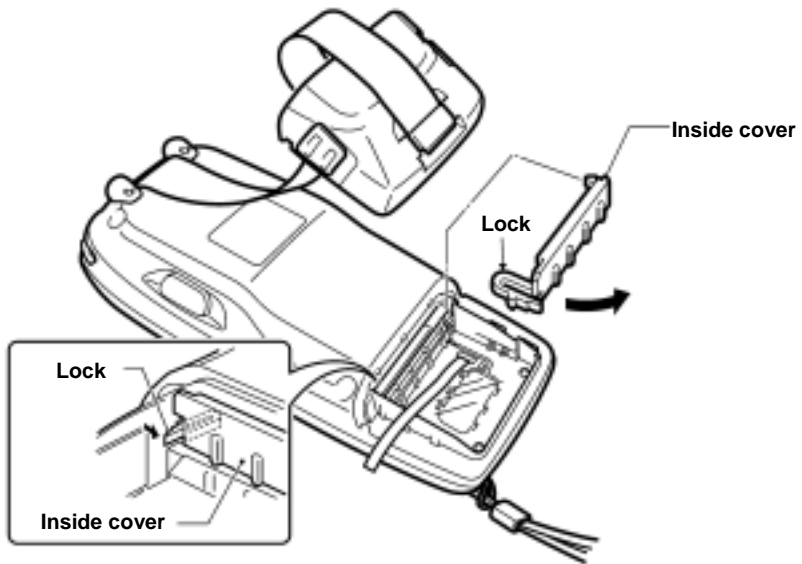

(5) Pull the right end of the clear insulation sheet up and out of the BHT.

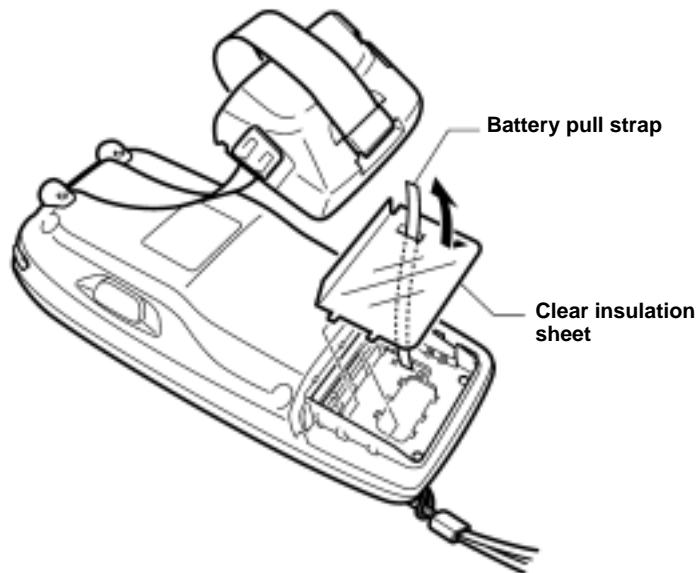

- (6) Slide the backup battery cover to the right and take it out.

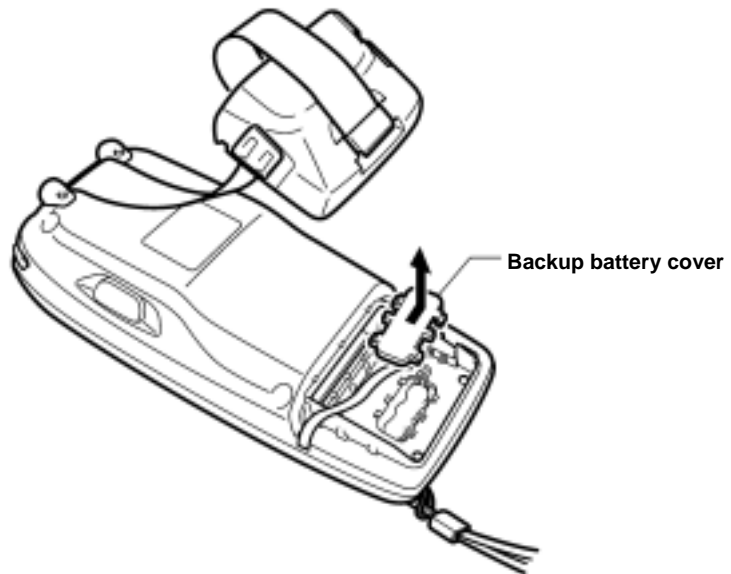

- (7) Lift up the backup battery, take its lead wires out of the groove, and disconnect the battery connector as shown below.

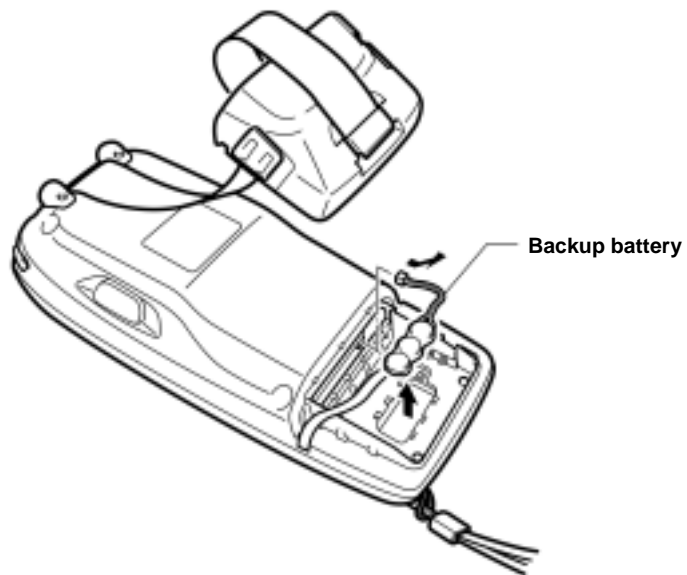

- (8) Connect the connector of a new backup battery with the red lead facing to the left.
- (9) Route the lead wires inside the guides through the groove. For easier routing, use a tool whose tip is thin and round.
- (10) Load the backup battery.

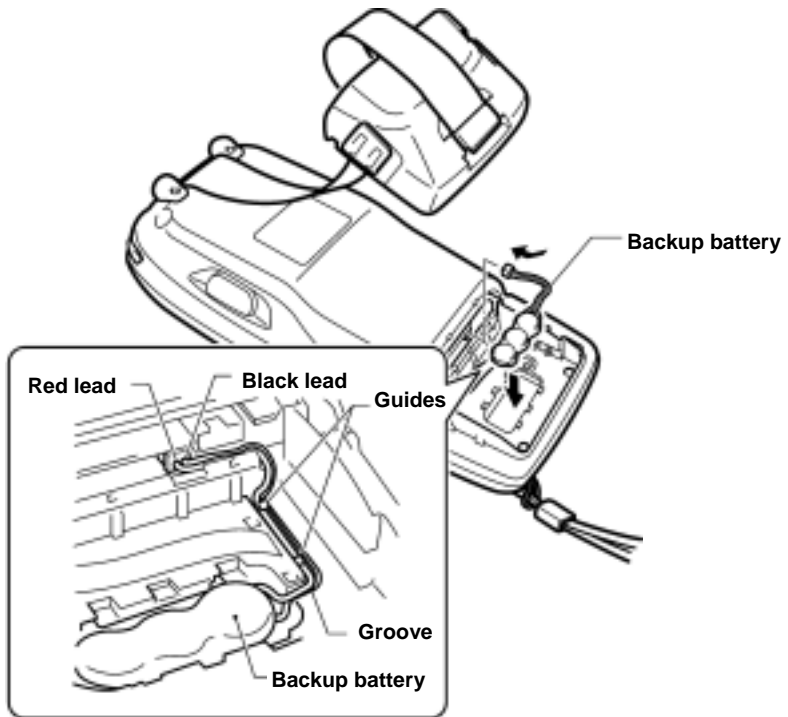

- (11) Slide the backup battery cover back into place.

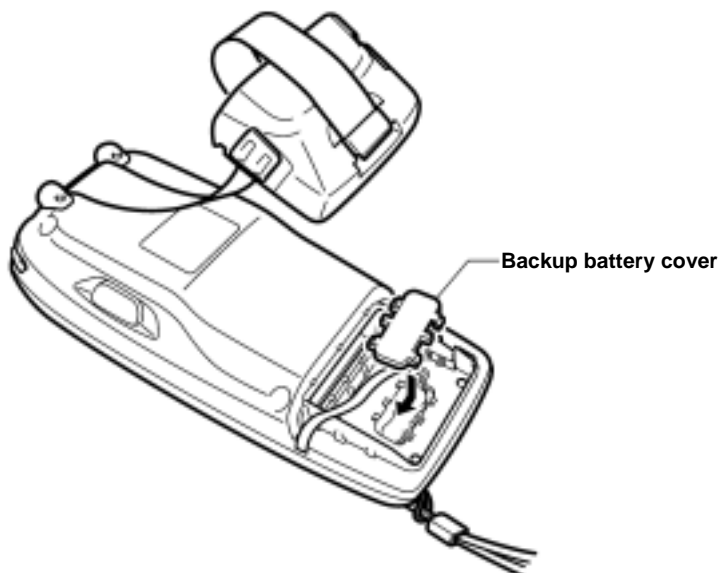

- (12) Set the clear insulation sheet back into place while threading the battery pull strap through the cutout in the sheet.

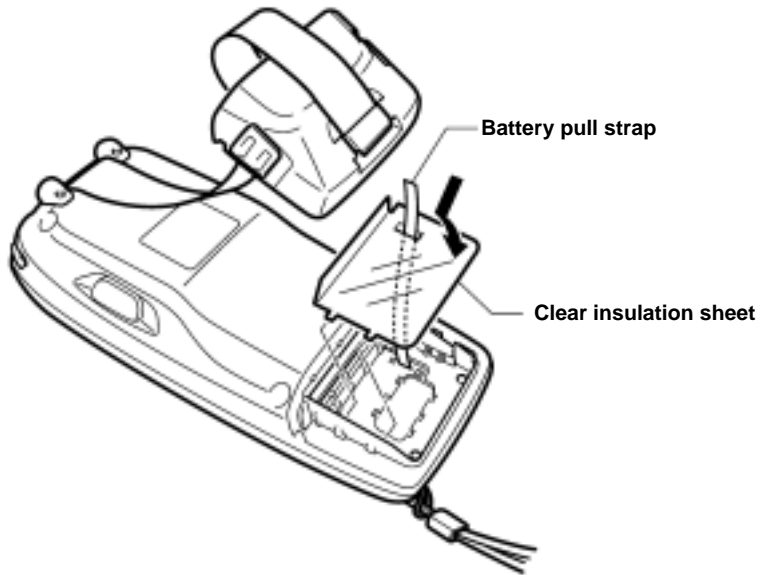

- (13) Set the inside cover so that its lock and pawl become fitted between the printed circuit boards.

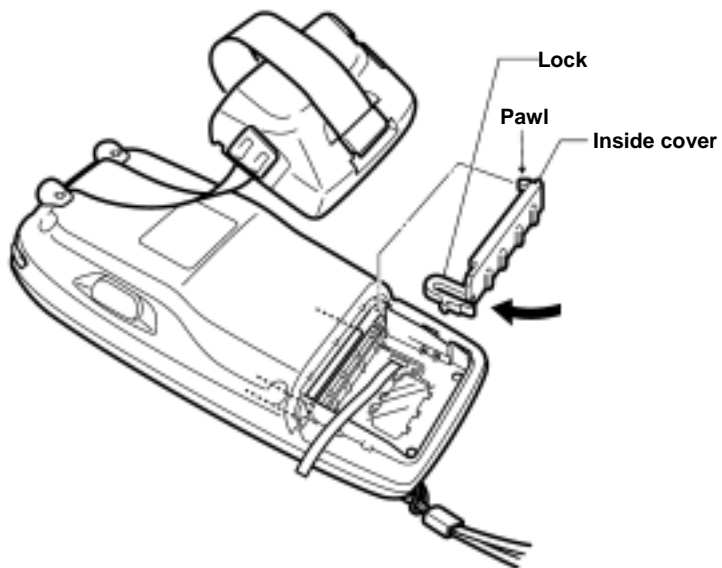

(14) Push the battery cartridge into the BHT. The end of the battery pull strap should come out from the left edge of the battery cartridge.

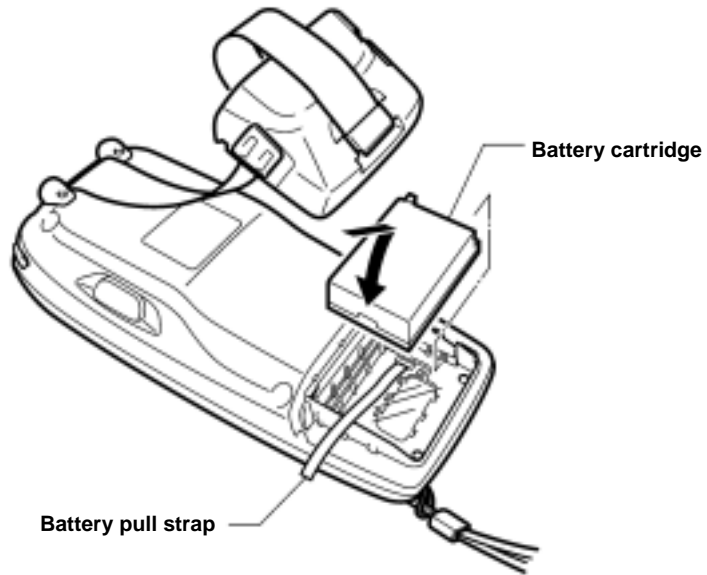

(15) Set the battery cartridge cover back into place and return the right and left release buttons to the original position.

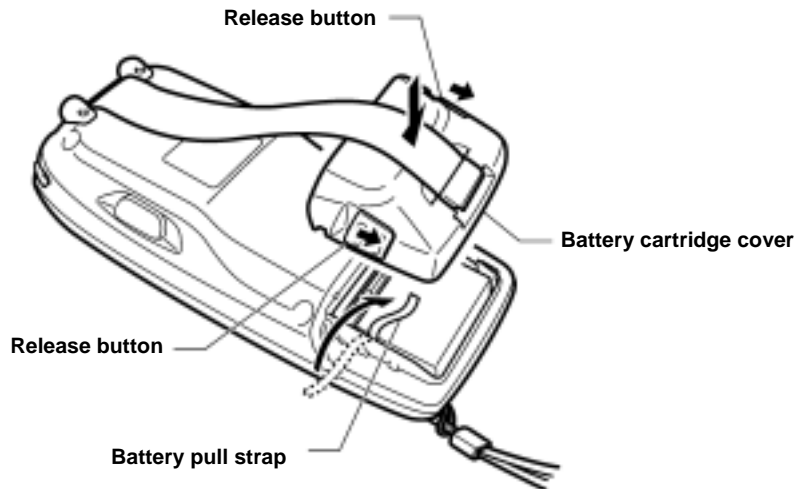

2.4.2 Resetting the Discharge Counter

If you replace the backup battery, reset the internal discharge counter in the BhtShell System Properties Menu. For detailed operation, refer to Section 2.5.4, "[3] System Properties Menu, ■ Backup Battery Discharge Counter."

2.5 Operating in System Menu

2.5.1 Desktop

Upon completion of setting-up 2 (described in Section 2.3.2), the desktop appears on the touch screen as shown below.

Double-tapping icons on the desktop runs the corresponding programs.

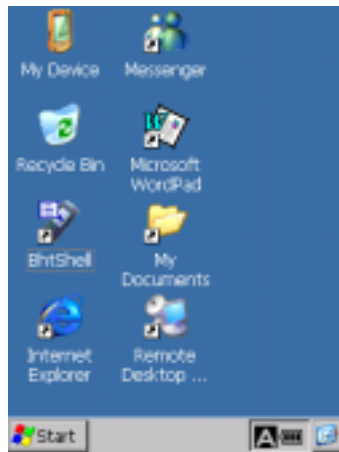

■ My Device

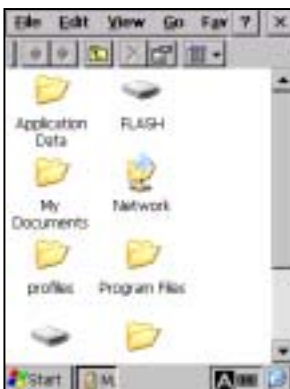

On the desktop, double-tap **My Device**. The screen shown at left appears.

With this program, you can browse the file information in the BHT.

■ Recycle Bin

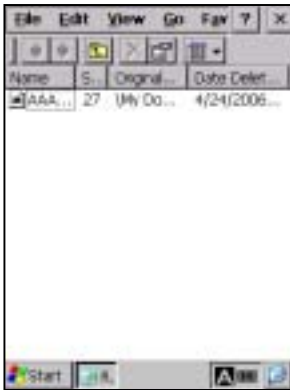

On the desktop, double-tap **Recycle Bin**. The Recycle Bin opens.

The Recycle Bin stores files you deleted in the BHT.

To retrieve files stored in the Recycle Bin, select the file to be retrieved and choose **File|Restore**.

To delete a file(s) in the Recycle Bin from the BHT memory permanently, select the file(s) to be deleted and choose **File|Delete**.

To delete all files in the Recycle Bin, choose **File|Empty Recycle Bin**.

NOTE If you delete files in the FLASH folder, they will not be stored in the Recycle Bin but deleted from the memory immediately.

■ BhtShell



On the desktop, double-tap **BhtShell**. The System Menu screen shown at left appears.

For details about this program, refer to Section 2.5.3, "Operating in System Menu."

■ Internet Explorer



On the desktop, double-tap **Internet Explorer**. The screen shown at left appears.

With this program, you can browse Web pages.

NOTE Before running Internet Explorer, you need to make RF-related settings and open the wireless communications device. For details, refer to Section 2.5.4, "[3.8] Radio Frequency."

TIP Configuring Proxy Server

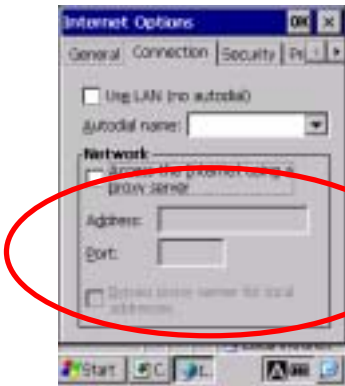

When the **Internet Explorer** runs, choose **View|Internet Options** to call up the Options window.

Tap the **Connection** tab to display the screen shown at left. Make your settings.

■ Messenger



On the desktop, double-tap **Messenger**. The screen shown at left appears.

■ Microsoft WordPad

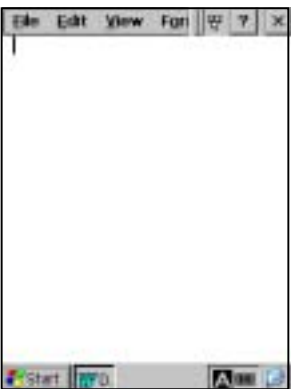

On the desktop, double-tap **Microsoft WordPad**. The screen shown at left appears.

■ My Documents



On the desktop, double-tap **My Documents**. The screen shown at left appears.

With this program, you can browse the file information in the BHT.

■ Remote Desktop Connection



On the desktop, double-tap **Remote Desktop Connection**. The screen shown at left appears.

2.5.2 Start Menu



Tap the  button in the bottom left corner of the desktop.

The Start menu appears where you can run programs and make system settings.

■ Terminal



On the **Start** menu, tap **Programs|Communication|Terminal**.

The screen shown at left appears. You can create a new session.

■ Internet Explorer

On the **Start** menu, tap **Programs|Internet Explorer** to run Internet Explorer.

For details, refer to Section 2.5.1, "Desk Top, ■ Internet Explorer."

■ Windows Explorer

On the **Start** menu, tap **Programs|Windows Explorer** to run Windows Explorer.

For details, refer to Section 2.5.1, "Desk Top, ■ My Device."

■ Command Prompt



On the **Start** menu, tap **Programs|Command Prompt**.

The screen shown at left appears.

■ Favorites

On the **Start** menu, tap **Favorites**.

Your Favorites list appears.

To add items to your Favorites list, create a shortcut(s) of the desired file(s) in the \Windows\favorites folder.

■ Documents

On the **Start** menu, tap **Documents**.

Recently opened documents appear.

To add files to the **Start** menu, use the standard API "SHAddToRecentDocs()". For details about SHAddToRecentDocs(), refer to the Help of application development tools.

■ Control Panel

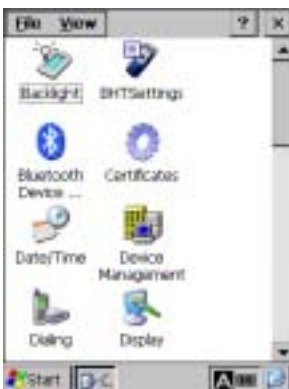

On the **Start** menu, tap **Settings|Control Panel**.

The screen shown at left appears.

You can configure the basic Windows operating environments in your BHT.

Backlight Properties

On the Control Panel window, double-tap **Backlight**, and the Backlight Properties window appears.

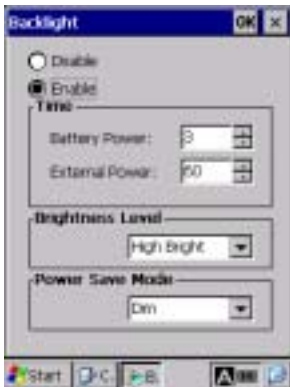

- **Backlight function**^(*1)

Enable or disable the backlight function. If it is enabled, the backlight comes on when you press any key or tap the touch screen.

- **Backlight On-duration**

Set the ON-duration of the backlight that comes on when you press any key or tap the touch screen.

Battery Power: ON-duration when the BHT is not placed on the CU.

External Power: ON-duration when the BHT is placed on the CU.

- **Brightness Level**

Select the desired brightness level from the following four choices:

(Dark)

Off
Low Bright |
Mid Bright |
High Bright

(Bright)

- **Power Save Mode**

Change the settings for turning off the backlight after the BHT has not been used for a specified period of time.

Off: The backlight turns off immediately.

Dim: The backlight remains on very dimly.

(*1)

Pressing the backlight function on/off key (the initial setting: the simultaneous depression of the **SF** key and right-hand trigger switch (**M4** key)) toggles between enabled and disabled states, regardless of the backlight function setting made on this screen.

BHTSettings



On the Control Panel window, double-tap **BHTSettings**, and the BHTSettings window appears.

For details, refer to Section 2.5.4. [3] "System Properties Menu."

System Properties

On the Control Panel window, double-tap **System**, and the System Properties window appears.



Tap the **General** tab to display the screen shown at left.



Choose the **Memory** tab to display the screen shown at left.

You can check the memory allocation and the free space of the RAM.

You can also change the memory allocation by moving the slider.

NOTE According to your operating requirements, assign the memory between "Storage memory" and "Program memory."

Depending upon the memory allocation (e.g., insufficient program execution space), the BHT might not operate normally.

Stylus Properties



On the Control Panel window, double-tap **Stylus**, and the Stylus Properties window appears.

You can adjust the double-tap speed.



Tap the **Calibration** tab to display the window shown at left.



Tap the **Recalibrate** to display the screen shown at left.

Follow the on-screen instructions. Refer to Section 2.3.2 "Setting-up 2: Calibrating the touch screen."

Dialing Properties



On the Control Panel window, double-tap **Dialing**, and the Dialing Properties window appears.

You can set up the telephone line.

Owner Properties

On the Control Panel window, double-tap **Owner**, and the Owner Properties window appears.



Tap the **Network ID** tab to display the window shown at left.

You can specify a user name, password and domain required to access the network resource.

Volume & Sounds Properties

On the Control Panel window, double-tap **Volume & Sounds**, and the Volume & Sounds properties window appears.



Tap the **Volume** tab to display the screen shown at left.

You can make the following settings:

- Adjust the beeper volume except volumes for key entry and screen taps
- Enable/disable the beeper for events
- Enable/disable the beeper driven by programs
- Enable/disable the beeper for notification

NOTE You may adjust the beeper volume to six levels (0 to 5) on this screen; however, four levels are available in practice since levels 1 and 2 and levels 3 and 4 produce the same volume.



Tap the **Sounds** tab to display the screen shown at left.

You can configure beeper sounds for various events.

Display Properties

On the Control Panel window, double-tap **Display**, and the Display Properties window appears.



Tap the **Background** tab to display the screen shown at left.

You can select wallpaper to be displayed on your desktop.



Tap the **Appearance** tab to display the screen shown at left.

You can specify the appearance of your desktop.

Regional Settings Properties



On the Control Panel window, double-tap **Regional Settings**, and the Regional Settings Properties window appears.

You can specify the display format for the following:

- Region
- Language
- Input

Connection

On the Control Panel window, double-tap **Network and Dial-up Connection**, and the Connection window appears.



Double-tap the "Make New Connection" icon starts Wizard.

Follow the Wizard instructions and set the connection name and type.

PC Connection Properties



Tap the **PC Connection** tab to display the screen shown at left.

You can change the connection method to the PC. Tap the **Change Connection** button.

Date/Time Properties



On the Control Panel window, double-tap **Date/Time**, and the Date/Time Properties window appears.

You can specify the date, time and time zone.

NOTE The entry range to the year is 2003 to 2099.

Input Panel Properties



On the Control Panel window, double-tap **Input Panel**, and the Input Panel Properties window appears.



Tap the **Options** button to display the screen shown at left.

You can switch the input panel (software keyboard) between large and small keys.

NOTE Regardless of the setting made for "Use gestures for...", the gestures* are always active.

*The Gesture refers to special stylus operations that enable special input on the software keyboard as shown at left.

■ Taskbar

On the **Start** menu, tap **Settings|Taskbar**. The Taskbar and Start Menu window appears.



Tap the **General** tab to display the screen shown at left.

You can customize the taskbar.

■ Run



On the **Start** menu, tap **Run**, and the screen shown at left appears.

You can run applications or open files.

2.5.3 Operating in System Menu

On the desktop, double-tap **BhtShell**. System Menu starts up to display the following screen:

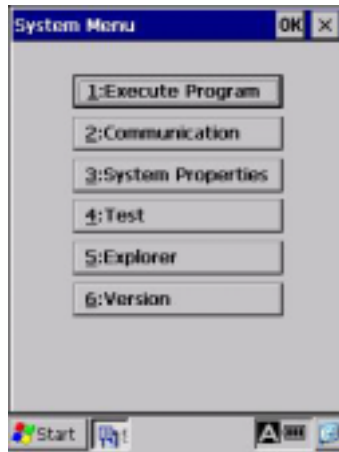

To run the items in System Menu, tap the desired item or press the corresponding numerical key.

To quit System Menu, tap the **OK** or **X** button located in the top right corner of the window.

The keys below are so designed that the function of each key is consistent in every screen.

Numerical keys	Pressing a numerical key corresponding with a desired menu number starts the desired item displayed on the screen.
ENT key	Pressing this key executes the focused* item.
Tab key (assigned to the M1 key by default)	Pressing this key moves the focus.
SF + C/BS (C) keys	Pressing this combination returns to the immediately preceding screen. **

* Currently active item. On the screen above, the [1:Execute Program] is focused.

** The combination of the **SF** and **C/BS (C)** keys is disabled on the following menus in Section 2.5.4, "Detailed Description of the Functions in System Menu."

- [2.1] Ymodem Menu
- [2.2] ActiveSync (Infrared)
- [2.3] ActiveSync (Serial)
- [2.4] ActiveSync (USB)
- [2.5] ActiveSync (RF)
- [3.3] Control Panel
- [3.8] Radio Frequency
- [5] Explorer

■ Structure of System Menu



System Menu

Double-tapping the **BhtShell** shortcut icon on the desktop starts up System Menu.

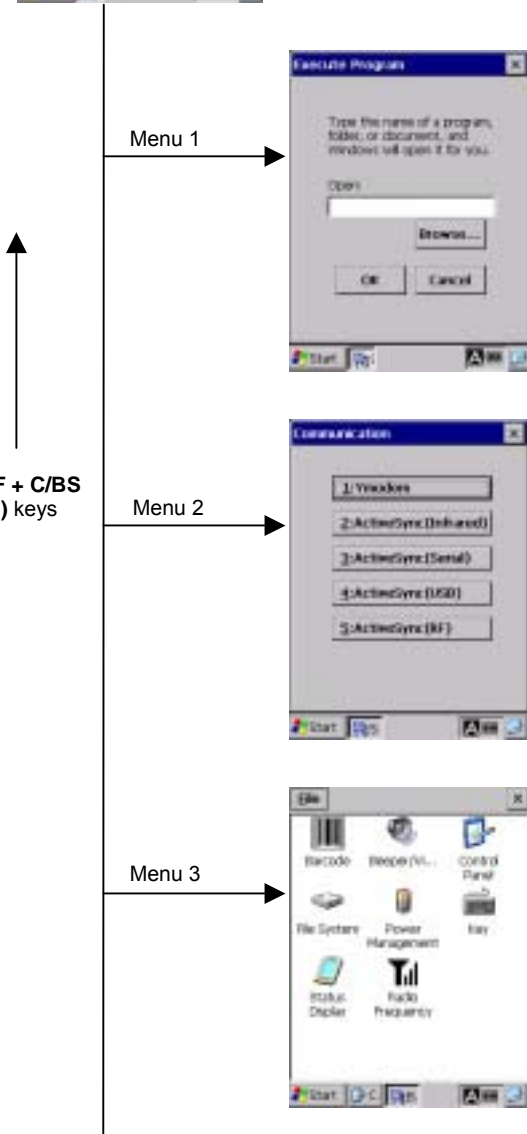

Execute Program

Executes a user program you select.
(Refer to Section 2.5.4, [1].)

Communication

Communicates with the host computer.
(Refer to Section 2.5.4, [2].)

System Properties

Sets a variety of environmental conditions.
(Refer to Section 2.5.4, [3].)

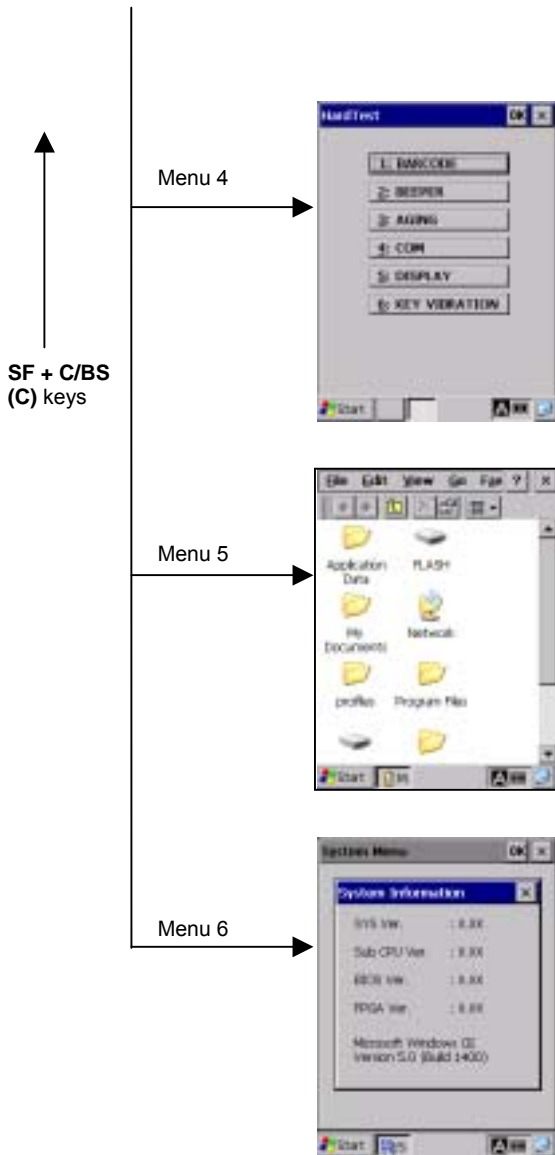

Hardware Test

Tests a variety of hardware operations.
(Refer to Section 2.5.4, [4].)

Explorer

Runs Explorer.
(Refer to Section 2.5.4, [5].)

System Information

Shows the system program version and memory size.
(Refer to Section 2.5.4, [6].)

2.5.4 Detailed Description of the Functions in System Menu

[1] Execute Program



Choosing "1:Execute Program" in System Menu calls up the screen shown at left.

With this menu, you can start an application you want.



Tap the **Browse** button. The screen shown at left appears.

Select a file you want to run, check that the file name is displayed in the **Name** box, and then tap the **OK** button.



Check that the name of the file to be run is displayed in the **Open** box and tap the **OK** button.

[2] Communication Menu



Choosing "2:Communication" in System Menu calls up the screen shown at left.

- [1] Ymodem: Switches to the Ymodem menu where you can set the Ymodem communications parameters and download/upload files.
- [2] ActiveSync (Infrared): Connects to the host computer via IrDA using ActiveSync.
- [3] ActiveSync (Serial): Connects to the host computer via a connector interface using ActiveSync.
- [4] ActiveSync (USB): Connects to the host computer via USB using ActiveSync.
- [5] ActiveSync (RF): Connects to the host computer via RF using ActiveSync.

[2.1] Ymodem Menu

With this menu, you can set the communications parameters and download or upload files from/to the host computer.



- ① Choosing "1:Ymodem" in the Communication menu calls up the screen shown at left.
- Button ①: Sets the communications environments.
- Button ②: Downloads a file to the BHT.
- Button ③: Uploads a file stored in the BHT to the host computer.

■ Setting the communications environments

Tapping button  on the Ymodem menu calls up the communications environments setting screen.

When using connector interface



To communicate with the host computer via the connector interface port, select "Serial (COM1:)" in **Port**. The screen shown at left appears.

In **BaudRate**, **Parity**, and **StopBits**, select the same setting as that in the host computer.

Data bits are fixed at 8.

When using IrDA interface



To communicate with the host computer via the IrDA interface port, select "IrDA (COM4:)" in **Port**. The screen shown at left appears.

In **BaudRate**, select the same setting as that in the host computer.

Other settings are fixed as follows:

- Data bits: 8
- Parity: None
- Stop bits: 1

After the BHT is initialized, the interface port and communications parameters are set as listed in the default table below.

Items	Defaults
Port	IrDA (COM4:)
Baud Rate	115200 bps
Data Bits	8
Parity	None
Stop Bits	1

■ Downloading



Specify a folder where you want to store a downloaded file and then tap button ②, and the BHT waits for a file to be downloaded.

Folder where you want to store a downloaded file

NOTE

If you download a file having the same name as one already in the same folder, the newly downloaded file replaces the old one.



Upon completion of downloading, the BHT sounds a long beep once and displays the screen shown at left.

If an error occurs during downloading

If some error occurs during downloading, the BHT beeps three times and shows one of the following screens.



■ Problem

The memory is insufficient for storing files to be downloaded.

■ Solution

Delete unnecessary files in the memory or decrease the size of the file to be downloaded.



■ Problem

The path of the file to be downloaded is too long.

■ Solution

Change the file name or the folder where you want to store the downloaded file.



■ Problem

The file you attempted to download was opened.

■ Solution

Close the file to be downloaded and then retry the download.



■ **Problem**

Downloading has failed.

■ **Solution**

Confirm the communications environment settings and then retry the download.

It is also necessary to check the communications environment setup of the host computer.



■ **Problem**

Downloading has aborted.

■ **Solution**

Confirm the communications environment settings and communications log, then retry the download.

It is also necessary to check the communications environment setup of the host computer.



■ **Problem**

The communications port has been already opened.

■ **Solution**

Close the communications port already opened for other processing and then retry the download.



■ **Problem**

Timeout has occurred.

■ **Solution**

Confirm the communications environment settings and communications log, then retry the download.

It is also necessary to check the communications environment setup of the host computer.

■ Uploading



Specify a file you want to upload and then tap button ③, and the BHT waits for a file to be uploaded.

File you want to upload



Upon completion of uploading, the BHT sounds a long beep once and displays the screen shown at left.

If an error occurs during uploading

If some error occurs during uploading, one of the following screens will appear and the beeper beeps three times.



■ **Problem**

The file you attempted to upload was opened.

■ **Solution**

Close the file to be uploaded and then retry the upload.



■ **Problem**

Uploading has aborted.

■ **Solution**

Confirm the communications environment settings and communications log, then retry the upload.

It is also necessary to check the communications environment setup of the host computer.



■ **Problem**

The communications port has been already opened.

■ **Solution**

Close the communications port already opened for other processing and then retry the upload.



■ **Problem**

Timeout has occurred.

■ **Solution**

Confirm the communications environment settings and communications log, then retry the upload.

It is also necessary to check the communications environment setup of the host computer.



■ **Problem**

No file has been correctly selected for uploading.

■ **Solution**

Select a file(s) to be uploaded and retry the upload.

[2.2] ActiveSync (Infrared)

Choosing "2:ActiveSync (Infrared)" on the Communication menu connects the BHT to the host computer via the IrDA interface port.



Upon completion of connection, the screen shown at left appears.

For details about the configuration of the host computer and connection using ActiveSync, refer to Chapter 3, Section 3.5 "ActiveSync."

NOTE When connecting the BHT to the host computer using ActiveSync (Infrared), arrange the BHT and host computer with their IrDA ports facing directly each other.

When the CU-201 with RS-232C interface is used to connect the BHT with the host, no ActiveSync can be used.

TIP The BHT can be setup so that ActiveSync, which allows connection with the host computer, begins automatically if the BHT is placed on the CU-221 while turned on.

For further details, refer to Section 2.5.4, "[3] System Properties Menu".

If ActiveSync connection succeeds



If ActiveSync connection succeeds, the BHT beeps once and displays the ActiveSync icon (circled in red at left) in the task tray.

If ActiveSync connection fails

If ActiveSync connection fails, the BHT beeps once and does not display the ActiveSync icon.

[2.3] ActiveSync (Serial)

Choosing "3:ActiveSync (Serial)" on the Communication menu connects the BHT to the host computer via the connector interface port.



After a connection is established, the screen shown at left appears.

For details about the configuration of the host computer and connection using ActiveSync, refer to Chapter 3, Section 3.5: "ActiveSync."

If ActiveSync connection succeeds



If ActiveSync connection succeeds, the BHT beeps once and displays the ActiveSync icon (circled in red at left) in the task tray.

If ActiveSync connection fails

If ActiveSync connection fails, the BHT beeps once and does not display the ActiveSync icon.

[2.4] ActiveSync (USB)

Choosing "4:ActiveSync (USB)" on the Communication menu connects the BHT to the host computer via the USB interface port.



Upon completion of connection, the screen shown at left appears.

For details about the configuration of the host computer and connection using ActiveSync, refer to Chapter 3, Section 3.5 "ActiveSync."

TIP The BHT can be setup so that ActiveSync, which allows connection with the host computer, begins automatically when the USB cable is plugged into the BHT when it is turned on.

For further details, refer to Section 2.5.4, "[3] System Properties Menu".

If ActiveSync connection succeeds



If ActiveSync connection succeeds, the BHT beeps once and displays the ActiveSync icon (circled in red at left) in the task tray.

If ActiveSync connection fails

If ActiveSync connection fails, the BHT beeps once and does not display the ActiveSync icon.

[2.5] ActiveSync (RF)

Choosing "5:ActiveSync (RF)" on the Communication menu connects the BHT to the host computer via the RF interface port.

NOTE

Before proceeding to "ActiveSync (RF)," you need to:

- Set up a partnership between the host computer and BHT by running "ActiveSync (Infrared)."
- Make the RF settings according to the procedure given in section 2.5.4 "[3.8] Radio Frequency." If the RF settings are not made correctly, "ActiveSync (RF)" cannot run.



When the BHT is opening the RF device and connecting to the network, it displays the screen shown at left.

NOTE

Connection to the network may take several tens of seconds depending upon the network environment. (When the DHCP is used for getting an IP address, connection to the network will require more time than when the IP address is fixed.)

If connection to the network cannot be completed, the RF settings may have not been made correctly. Check the RF settings again.



Upon completion of connection to the network, the screen shown at left appears.

Select "Network Connection" as connection method and select the name of the host computer in the **Connect to** box. Then tap the **Connect** button.





Upon completion of connection by ActiveSync, the screen shown at left appears.

If connection to the network fails

If connection to the network fails, the BHT beeps three times and displays the following screen.

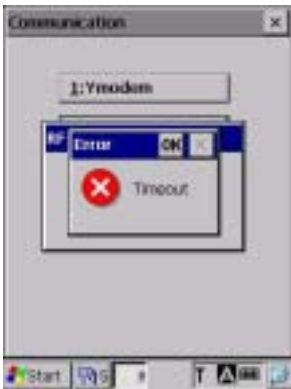

■ **Solution**

The RF settings may have not been made correctly. According to the procedure given in section 2.5.4 "[3.8] Radio Frequency," make the correct RF settings.

If no partnership has been set up

If no partnership has been set up between the host computer and BHT, the BHT beeps three times and displays the following screen.



■ **Solution**

Set up a partnership according to the procedure given in Section 3.5.2, "Connection Using ActiveSync."

[3] System Properties Menu



Choosing "3: System Properties" in System Menu calls up the window shown at left.

- | | |
|-----------------------|----------------------------------|
| [1] Barcode: | Opens the Barcode menu. |
| [2] Beeper/Vibration: | Opens the Beeper/Vibration menu. |
| [3] Control Panel: | Opens the Control Panel window. |
| [4] File System: | Opens the File System menu. |
| [5] Power Management: | Opens the Power Management menu. |
| [6] Key: | Opens the Key menu. |
| [7] Status Display: | Opens the Status Display menu. |
| [8] Radio Frequency: | Opens the NIC Control menu. |

[3.1] Barcode



On the System Properties Menu, double-tap the "Barcode", and the Barcode property appears.

- | | |
|---------------|---|
| INVERT: | Activates or deactivates the black-and-white inverted label reading function. |
| DECODE LEVEL: | Sets the decode level. |
| MARKER: | Sets the marker ON/OFF mode. |
| ITF: | Sets the default minimum number of digits to be read for ITF. |
| STF: | Sets the default minimum number of digits to be read for STF. |
| CODABAR: | Sets the default minimum number of digits to be read for CODABAR. |

Black-and-white inverted label reading function (INVERT)

This function makes it possible to read white bars on a black background.

NOTE

Activating this function might increase the frequency of bar-code reading errors. Usually this function should be set to OFF.

DECODE LEVEL

You may set the decode level. Decreasing the level value increases the bar-code reading efficiency, but the BHT might misread low-quality bar codes (split or stained). To the contrary, increasing the level value decreases the bar-code reading efficiency, but it will diminish the possibility of misreading.

The setting range of the level value is from 1 to 9 and the default is 4.

MARKER

You can select the marker ON/OFF mode from the following:

Normal: Normal mode driven by the trigger switch

None: OFF mode

In Normal mode, the marker comes on at the same time as the illumination LED does.

Minimum number of digits to be read for ITF, STF, or CODABAR

You can set the minimum number of digits to be read for ITF, STF, and CODABAR.

Setting a small number of digits increases the frequency of digit-missing reading or misreading depending upon how to scan bar codes or the quality of bar codes. On the other hand, setting a large number will diminish the possibility of those errors.

The setting range is from 2 to 20 for ITF, from 1 to 20 for STF, and from 3 to 20 for CODABAR. The default is 4 for ITF and CODABAR, and 3 for STF.

[3.2] Beeper/Vibration



Double-tap the "Beeper/Vibration", and the Beeper/Vibration property appears.

On this menu, you can adjust the beeper volume and switch the beeper and vibrator.

Adjusting the beeper volume

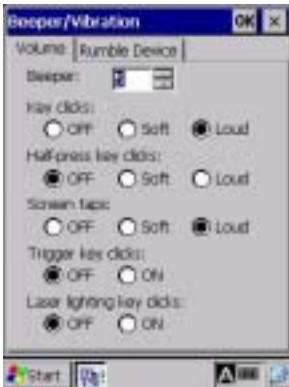

Choose the **Volume** tab to display the screen shown at left where you can select the beeper volume for the following operations.

- | | |
|-----------------------------|--|
| Beeper: | From the six levels 0 (low) to 5 (high). (Default: 5) |
| Key clicks: | Beeper volume to be applied when any key is pressed. (Default: Loud) |
| Half-press key clicks: | Beeper volume to be applied when any key is halfway pressed. (Default: OFF) |
| Screen taps: | Beeper volume to be applied when the screen is tapped. (Default: Loud) |
| Trigger key clicks*: | Beeper volume to be applied when the trigger switch is pressed. (Default: OFF) |
| Laser lighting key clicks*: | Beeper volume to be applied when the laser lighting key is pressed. (Default: OFF) |

*The trigger switch or laser lighting key can be assigned to magic keys.

Switching the beeper and vibrator



Choose the **Rumble Device** tab to display the screen shown at left.

You may select any of three ways--beeping only, vibrating only, and beeping and vibrating as a confirmation of completion of bar code reading.

- | | |
|-------------------|------------------------|
| Beeper: | Beeping only (default) |
| Vibration: | Vibrating only |
| Beeper/Vibration: | Beeping and vibrating |

[3.3] Control Panel



Double-tap the "Control Panel", and the Control Panel window appears.

With this menu, you can set up the basic Windows operating environment. For details, refer to Section 2.5.2 "■ Control Panel."

[3.4] File System



Double-tap the "File System", and the File System property appears.

With this menu, you can perform the following transactions:

- Initializing the memory excluding the Registry
- Initializing the memory including the Registry
- Initializing the FLASH folder
- Running Scandisk through the FLASH folder

The table below shows which memory area will be initialized by the initialization transactions listed above.

	Initializing the memory		Initializing the FLASH folder
	Excluding the Registry	Including the Registry	
Data stored in the FLASH folder	Not initialized	Not initialized	Initialized
Data stored in other folders	Initialized	Initialized	Not initialized
Registry	Not initialized	Initialized	Not initialized*

* Note that the backup of the Registry will be erased. To back up the Registry again, follow the procedure given in Section 2.3.4, "[2] Backing up the Registry."

■ Initializing the memory excluding the Registry

You can initialize the memory excluding the Registry and files stored in the FLASH folder.



↓ ↑ Select **No**.



↓ Select **Yes**.



Initializing procedure

(1) Tap the **Initialize** tab and select the **RAM** radio button.

(2) Tap the **Initialize** button.

(3) To initialize the memory, tap the **Yes** button; to return to the previous menu, tap the **No** button.

After the BHT displays the screen shown at left for a few seconds, it will automatically reboot.

■ Initializing the memory including the Registry

You can initialize the memory including the Registry but excluding files stored in the FLASH folder.



Initializing procedure

- (1) Tap the **Initialize** tab and select the **RAM** radio button.
- (2) Select the **Initialize Registry** check box
- (3) Tap the **Initialize** button.

⇓ ⇑ Select **No**.



- (4) To initialize the memory, tap the **Yes** button; to return to the previous menu, tap the **No** button.

⇓ Select **Yes**.



After the BHT displays the screen shown at left for a few seconds, it will automatically reboot.

■ Initializing the FLASH folder

You can erase all information stored in the FLASH folder and let the folder revert to the initial state.



Initializing procedure

- (1) Tap the **Initialize** tab and select the **FLASH** radio button.
- (2) Tap the **Initialize** button.

↓ ↑ Select **No**.



- (3) To initialize the memory, tap the **Yes** button; to return to the previous menu, tap the **No** button.

↓ Select **Yes**.



Upon completion of initialization (it will take approx. one minute), the screen shown at left appears.

■ Running Scandisk through the FLASH folder

If the power to the BHT is shut down when the FLASH folder is being accessed, some broken file fragments may remain in the FLASH folder so that the free memory space will be decreased.

To remove or clear those fragments, run Scandisk through the FLASH folder.



Initializing procedure

(1) Tap the **Scandisk** tab and select the **Scandisk** button.

↓ ↑ Select **No**.



(2) To initialize the memory, tap the **Yes** button; to return to the previous menu, tap the **No** button.

↓ Select **Yes**.



Upon completion of Scandisk (it may take a few minutes depending upon the use conditions of the FLASH folder), the screen shown at left appears.

[3.5] Power Management

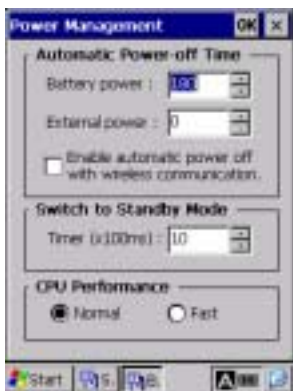

Double-tap the "Power Management", and the Power Management property appears.

You can set the automatic power-off timer, the standby timer, and CPU clock.

Automatic Power-Off Time:

Battery Power: For the BHT being out of the CU, set the automatic power-off timer. (Default: 180)

External Power: For the BHT placed in the CU, set the automatic power-off timer. (Default: 0)

The entry range for the above items is from 0 to 32767 in units of seconds. Specification of 0 disables the automatic power-off facility.

When the **“Enable automatic power off with wireless communication”** check box is selected, the power turns OFF automatically when not performing communication, even if a wireless connection is open.

Switch to Standby Mode:

Timer (x100 ms): Set the waiting time to switch to the standby mode within the range from 0 to 32767 in units of 100 ms. (Default: 10, 100 ms x 10 = 1 second)

CPU Performance:

Normal: Select Normal to operate the CPU at typical clock speed. (Default)

Fast: Select Fast to operate the CPU at higher clock speed.

NOTE

- Setting the CPU performance to Fast consumes much power, decreasing the BHT operation period after battery charge.
- CPU performance settings will be functional after the setting changes are made.

[3.6] Key



Double-tap the "Key", and the Key property appears.

You can define the functions of the following keys:

- **SF/ALP (SF)** key
- **M1** key
- **M2** key
- **M3** key
- **M4** key
- **M5** key*
- **M3** key (pressed halfway)
- **M4** key (pressed halfway)
- **M5** key* (pressed halfway)

*Available on the grip style BHT

Defining the SF/ALP (SF) key for keypad shift



Choose the **SHIFT** tab on the Key definition menu to display the screen shown at left.

Nonlock: Shifts the keypad only when the **SF/ALP (SF)** key is held down.

Onetime: Shifts only one key pressed immediately after the **SF/ALP (SF)** key is pressed. (The following keys will not be shifted.)

Defining the M1, M2, M3 (left-hand trigger switch), M4 (right-hand trigger switch), and M5* keys

*M5 key available on the grip style BHT



Choose the **MAGIC Full-press** tab on the Key definition menu to display the screen shown at left.

You can define each of the **M1** through **M5*** keys as any one of a trigger switch, shift key, enter key, backlight function on/off key, Tab key and others as listed below.

Defining the halfway pressed M3 through M5* keys



Choose the **MAGIC Half-press** tab on the Key definition menu to display the screen shown at left.

You can define each of the halfway pressed **M3** through **M5*** keys as any one of a trigger switch, shift key, enter key, backlight function on/off key, Tab key and others as listed below.

Choice of keys available

In each of the combo boxes on the MAGIC Full-press and Half-press pages above, you can make a choice from a list of keys given below.

The **M1** through **M5*** keys and the halfway pressed **M3** through **M5*** keys can function as listed below. (This sample defines the **M1** key as a Tab key.)



- None: The key entry will be ignored.
- Trigger Switch: As a trigger switch.
- Shift Key: As a **SF/ALP (SF)** key.
- Enter Key: As an **ENT** key.
- Backlight Key: As a backlight function on/off key.
- Tab: As a tab key.
- Laser: As a laser lighting key.
- Control: As a **CNTL** key.
- Alternate: As an **ALT** key.
- CLEAR: As a **CLEAR** key.

NOTE

If you define the **M4** key as a backlight function on/off key, pressing the **M4** key activates or deactivates the backlight function.

Note that the backlight function on/off key can be assigned only to any one of **M1** through **M5*** keys and halfway pressed **M3** through **M5*** keys. The key defined more recently will act as a backlight function on/off key and one defined earlier will be ignored.

That is, if you define the **M1** and **M2** keys as a backlight function on/off key in this sequence, the **M2** key will work as a backlight function on/off key and the **M1** key's entry will be ignored.

If a backlight function on/off key is not assigned to any of the **M1** through **M5*** keys and halfway pressed **M3** through **M5*** keys, the combination of the **SF/ALP (SF)** and **M4** keys work as a backlight function on/off key by default.

***M5** key available on the grip style BHT

User-defined code file

User-defined virtual key codes can be assigned to magic keys.

Enter the desired virtual key codes into a text file and save it in the FLASH folder of the BHT, with the filename "MKeyDef.txt".

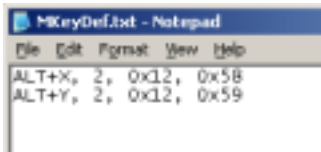

```
MKeyDef.txt - Notepad
File Edit Format View Help
ALT+X, 2, 0x12, 0x58
ALT+Y, 2, 0x12, 0x59
```

The screen shown to the left is an example for adding ALT+X and ALT+Y.

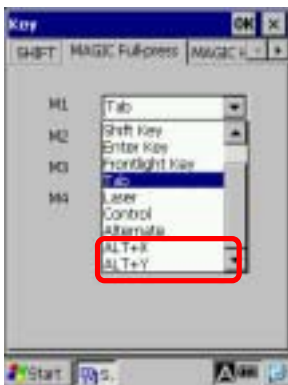

The code file is read when the Key definition menu is started

The defined key codes are displayed below "Alternate" in the same order as entered in the text file.

For further details, refer to the "BHT-200-CE API Reference Manual" or "BHT-200-CE Class Library Reference Manual."

[3.7] Status Display



Double-tap the "Status Display", and the Status Display property appears.

You can display or hide the following status indicators in the task tray:

BATTERY:	Battery voltage level
RF	Synchronization state
SIP:	Software input panel (Software keyboard)
SHIFT:	Keypad shift state
CPU STANDBY:	Standby state of the CPU
ALPHA:	Alphabet entry mode status

The defaults of the items above except the CPU STANDBY are "Display."

For details, refer to Section 2.2.2, "Status Indicators on the LCD."

[3.8] Radio Frequency



Double-tap the "Radio Frequency", and the NIC Control property appears.

The NIC Control property has the following tabs:

- Info tab: Displaying the wireless module version and opening/closing the RF device
- Network tab: Displaying the IP address and MAC address
- ID tab: Setting the ESSID
- Option tab: Setting the RF options
- WEP tab: Setting the WEP keys
- Link tab: Displaying the current communications link status
- Ping tab: Testing with Ping

■ Displaying the wireless module version and opening/closing the RF device



Tapping the **Info** tab on the NIC Control menu displays the screen shown at left.

This menu displays the following:

- Driver Version: Version of the RF driver
- Firmware Version: Firmware version of the wireless module
- Hardware Version: Hardware version of the wireless module

You can also open or close the wireless module by tapping the **RF Open**, **RF Close** or **RF Open Continuously** button, respectively

NOTE If the wireless module is opened by pressing [RF Open], Closing the NIC Control property automatically closes the RF device even if being opened. If you need to display any other window while keeping the RF device open, tap the button on the taskbar to minimize the NIC Control property window.

If the wireless module is opened by pressing [RF Open Continuously], the wireless module remains continuously open even if the NIC Control property is closed. To close the wireless module, open this menu again and tap the [RF Close] button.

■ Displaying the IP address and MAC address



Tapping the **Network** tab on the NIC Control menu displays the screen shown at left.

This menu displays the following:

- DHCP/Static: DHCP enabled or disabled
- IP Address: IP address of the BHT
- Subnet mask: Subnet mask
- Gateway: Default gateway
- DNS Server: IP address of the DNS
- WINS Server: IP address of the WINS
- MAC Addr: MAC address of the BHT

Tapping the **Property** button calls up the IP address setting screen. For the IP address setting procedure, refer to Section 2.5.2, "■ Control Panel, Owner Properties."

TIP When the RF device is not opened, the MAC address shows "00:00:00:00:00:00."

■ Setting the ESSID



Tapping the **ID** tab on the NIC Control menu displays the screen shown at left.

You can specify an ESSID (Extended Service Set ID) to be used on the communications network. For details about the ESSID, refer to Chapter 3, Section 3.1.2, "RF-Related Parameters."

■ Setting the RF options



Tapping the **Option** tab on the NIC Control menu displays the screen shown at left.

You can set the following:

Power: Select the power mode for the wireless module.

Zero config: Select the Zero config mode.

For details about the parameters above, refer to Chapter 3, Section 3.1.2 "RF-Related Parameters."

■ Setting the WEP keys



(Authentication: Open)

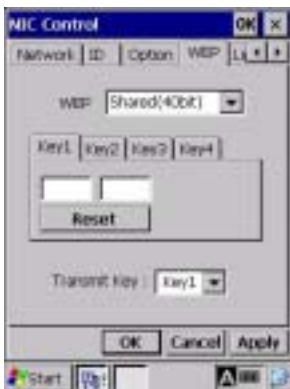

(40-bit WEP)

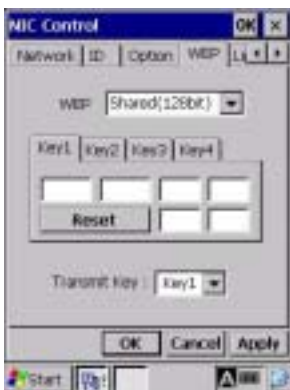

(128-bit WEP)

Tapping the **WEP** tab on the NIC Control menu displays any of the following three types of screens according to the authentication type.

- At left: Open
- Below at left: Shared key (40-bit WEP)
- On the next page: Shared key (128-bit WEP)

You can set the following:

WEP: Set the authentication system when the WEP is enabled.

Open: Disable the encryption.

Shared (40-bit): Use a 40-bit WEP key.

Shared (128-bit): Use a 128-bit WEP key.

Key 1 through 4: Define four types of encryption keys--WEP keys 1 to 4. (available only when the Shared (40-bit) or Shared (128-bit) is selected)

Transmit Key: Activate any one of the WEP keys 1 through 4 already defined. (available only when the Shared (40-bit) or Shared (128-bit) is selected)

NOTE To enable the encryption with an WEP key, choose "Shared" in the WEP box.

For Transmit Key, select an WEP key already defined.

For details about each parameter, refer to Chapter 3, Section 3.1.2, "RF-Related Parameters."

■ Displaying the current communications link status



Tapping the **Link** tab on the NIC Control menu displays the screen shown at left where the current communications link status appears in real-time.

Associated Access Point:

Displays the MAC address assigned to the wireless interface of the associated access point.

Signal Strength:

Displays the signal intensity of receive packets.

Beacons Received:

Displays the progress bar that shows the percentage of received beacon packets relative to those to be received.

Beacon: Synchronous signals transmitted periodically from the access point

Link Quality:

Displays the comprehensive link operation level with the access point.

If the following shows:	Communications state
Excellent	Excellent communications link ↑ ↓
Good	
Fair	
Poor	Poor communications link
Not Associated	Not associated with an access point

Link Speed: Displays the current transmission speed.

Channel: Displays the current communications channel.



Tapping the **Link** tab when the RF device is not opened automatically opens the RF device and displays the current communications link status.

■ **Testing with Ping**



Tapping the **Ping** tab on the NIC Control menu displays the screen shown at left.

- Dest IP:** Specify the IP address of a host computer that you want to ping.
- Data size:** Specify the data size of an echo request.
- Interval:** Specify the echo request intervals (in units of 100 ms).
- Timeout:** Specify the timeout period (in units of 100 ms) for an echo request.
- Type 1 or Type 2:** Select the echo request send timing Type 1 or Type 2 (described on the next page).
- Count:** Specify the number of echo requests to be sent.

To run Ping, tap the **Ping Start** button or press the **ENT** key.

TIP Tapping the **Ping Start** button when the RF device is not opened automatically opens the RF device and runs Ping.

Entry Range for Data size, Interval, Timeout, and Count

Item	Allowable entry range	Initial value
Data size	1 to 2048	32
Interval	0 to 65535	10
Timeout	0 to 65535	10
Count	0* to 65535	4

* Specification of zero (0) will set the number of echo requests to be sent to "infinite," keeping sending echo requests (until Ping is aborted).

If you specify a value out of the allowable entry range listed above, the nearest value within the range will automatically apply.



After Ping runs, the screen shown at left appears.

- Count:** Number of echo requests sent
- OK:** Number of echo replies
- NG:** Number of errors found during execution of Ping
- Timeout:** Number of timeouts (for echo replies) that took place during execution of Ping
- RTT Ave. (ms):** Echo reply time in milliseconds

Ping Echo Request Send Timing

Two types of echo request send timings are available: Type 1 and Type 2. The default is Type 2.

• Type1

After sending an echo request, Ping will wait for the period specified by Interval and then send an echo request again.

For Type 1, the relationship between the Interval and Timeout should be "Interval \geq Timeout."

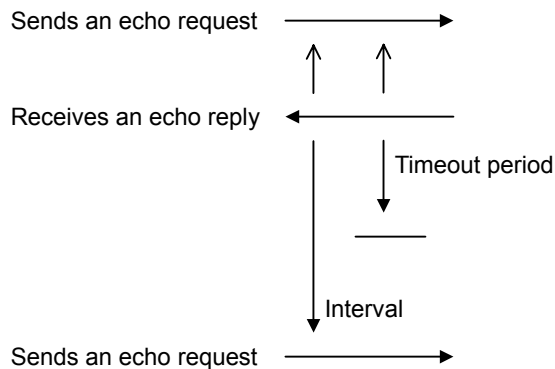

• Type2

After sending an echo request, Ping will wait for an echo reply to be received or for timeout to occur. After that, Ping will wait for the period specified by Interval and then send an echo request again. For Type 2, no relationship between the Interval and Timeout is required.

If Ping receives an echo reply:

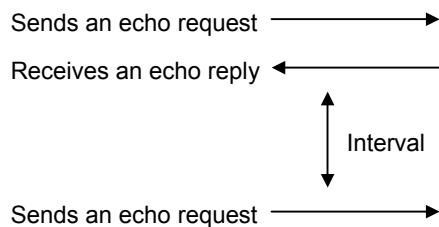

If timeout occurs:

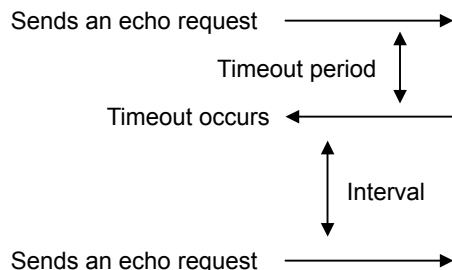

■ Backup Battery Discharge Counter



On the System Properties Menu, pressing the **0** key with the **SF/ALP (SF)** key held down calls up the screen shown at left.

This screen displays the discharge count of the backup battery.

If you replace the backup battery, tap the Reset button to reset the discharge counter to zero.

NOTE Only after the discharge count reaches 200, the counter can be reset to zero.

■ ActiveSync automatic connection



On the System Properties Menu, pressing the **1** key with the **SF/ALP (SF)** key held down calls up the screen shown at left.

On the ActiveSync page, select “Infrared” or “USB” in the “Automatic Connection” group box.

Infrared: Turns on automatic connection via the infrared port

USB: Turns on automatic connection via the USB port

Tapping the **OK** button validates the setting.

* The CU-221 is needed.

TIP Automatic connection is disabled by default.

[4] Test Menu



Choosing "4:Test" in System Menu calls up the screen shown at left.

- [1] BARCODE: Select the bar-code reading test.
- [2] BEEPER: Select the beeper scale test.
- [3] AGING: Select the aging test.
- [4] COM: Select the communications test.
- [5] DISPLAY: Select the LCD and indicator LED.
- [6] KEY VIBRATION: Select the key entry and vibrator test.

NOTE

If an error occurs in any of the above tests, contact your nearest dealer.

[4.1] Bar-code reading test

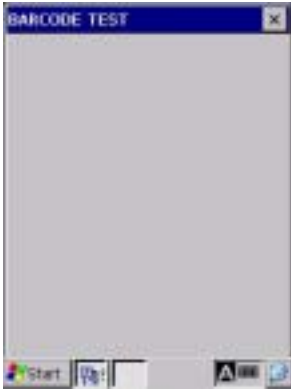

Selecting "1: BARCODE" on the Hard Test menu calls up the screen shown at left.

Actually read bar codes with the BHT and check that the barcode data read matches ones displayed on the LCD.

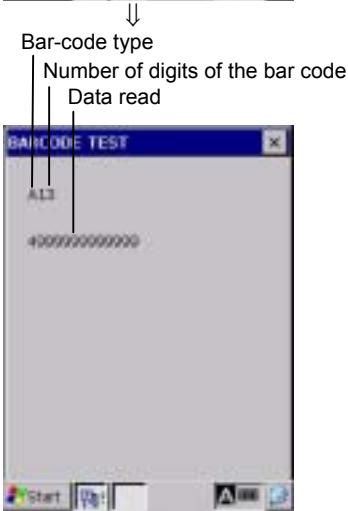

Upon completion of bar-code reading, the BHT beeps once, turns on the indicator LED in blue, and displays the read data together with the barcode type and the number of digits.

Listed below is a table showing the relationship between the barcode types and the identifier letters to be displayed on the LCD.

Bar-code Type	ID Letters
EAN-13, UPC-A	A
EAN-8	B
UPC-E	C
Standard 2of5 (STF)	H
Interleaved 2of5 (ITF)*	I
CODABAR (NW-7)*	N
Code 39	M
Code 93	L
Code 128	K
MSI	P
EAN-128	W

* The minimum number of digits to be read is 3 for STF and CODABAR, and 4 for ITF.

[4.2] Beeper scale test

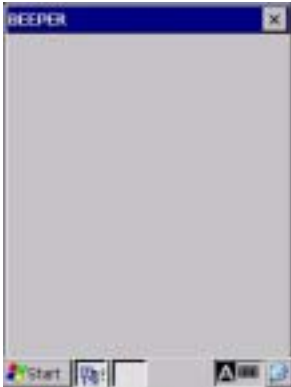

Selecting "2:BEEPER" on the Hard Test menu calls up the screen shown at left and sounds the beeper at three octaves listed below.

Upon completion of this test, the BHT automatically returns to the Hard Test menu.

Scale	Frequency (Hz)			
	do	re	mi	fa
do	523	1046	2093	4186
re	587	1174	2349	-
mi	659	1318	2637	-
fa	698	1396	2793	-
sol	783	1567	3135	-
la	880	1760	3520	-
ti	987	1975	3951	-

[4.3] Aging test



Selecting "3:AGING" on the Hard Test menu proceeds to the aging test while showing the current date and time on the LCD. (This test is intended for personnel who check the BHT in the factory.)

TIP Once this test is selected, the automatic powering-off function becomes disabled.

[4.4] Communications test

In System Menu, you can test the IrDA interface port and USB interface port.

■ Preparation for the IrDA interface test

Arrange two BHTs, one as a master station and the other as a slave station (to be tested) with their IR ports facing each other as illustrated below. In this test, the slave BHT transmits data to the master BHT and receives the data sent back from the master BHT.

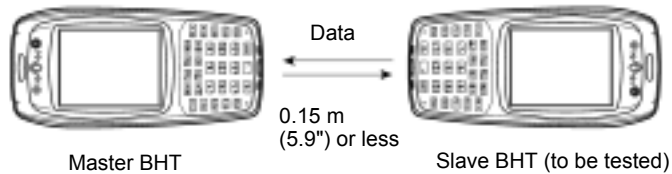

■ Preparation for the USB interface test

Connect the BHT and the host computer using a USB interface cable.



Selecting the "4:COM" on the Hard Test menu calls up the screen shown at left.

[1] OPTICAL: Switch to the MASTER/SLAVE selection screen for the IrDA interface test.

[2] USB: Test the USB interface port.

Testing the IrDA interface port



Selecting the "1:OPTICAL" on the COM menu calls up the screen shown at left.

At the slave BHT to be tested, select the "1:SLAVE" and at the master BHT, select the "2:MASTER."

Then press the **ENT** key on each BHT.



During the test, the screen shown at left is displayed.

XXXXX: Transmission speed (2400, 9600, or 115200 bps)

YYY: Hex data being sent (0 to 256)



Upon normal completion of the test, the tested slave BHT beeps once and displays the screen shown at left.

The master BHT automatically returns to the COM menu.

If the IrDA interface test ends abnormally:



If the test ends due to a timeout error, the tested slave BHT beeps three times and displays the screen as shown at left.

This sample screen shows that an error has occurred at 2400 bps.



If the test ends due to mismatch between the sent data and received data, the tested slave BHT beeps three times and displays the screen as shown at left.

This sample screen shows that the received data is 196 although data 17 has been sent at 2400 bps.

Testing the USB interface port



Selecting the "2:USB" on the COM menu calls up the screen shown at left and starts connecting with the host computer using ActiveSync.

For the configuration of the host computer and details about ActiveSync, refer to Chapter 3, Section 3.5 "ActiveSync."

If ActiveSync connection succeeds via the USB interface port



If ActiveSync connection succeeds, the BHT beeps once and displays the ActiveSync icon (circled in red at left) in the task tray.

If ActiveSync connection fails via the USB interface port

If ActiveSync connection fails, the BHT beeps once and does not display the ActiveSync icon.

To terminate the USB interface test

There are two ways to terminate the USB interface test--"Disconnect the USB interface cable" and "Disconnect the link with the button in the task tray (as described below)."



- (1) Double-tap the ActiveSync icon (circled in red at left) in the task tray.

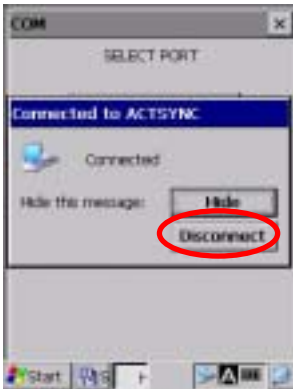

- (2) The dialog appears as shown at left. Tap the **Disconnect** button (circled in red).

The BHT beeps once and disconnects the ActiveSync connection. The ActiveSync icon disappears.

[4.5] LCD and indicator LED tests



Selecting "5:DISPLAY" on the Hard Test menu calls up the test pattern shown at left on the LCD and turns on the indicator LED in blue.

Each time the **ENT** key is pressed, the screen shifts to the next test pattern. To return to the previous screen, press the **C/BS (BS)** key.

To stop this test while in progress and return to the Hard Test menu, press the **C/BS (C)** key.

C/BS (BS) key ↑ ↓ **ENT** key

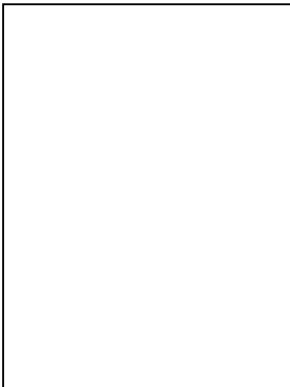

As shown at left, everything disappears and the indicator LED lights in red.

C/BS (BS) key ↑ ↓ **ENT** key

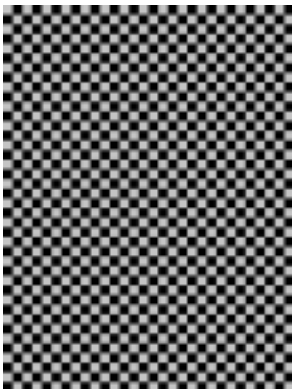

The checker pattern shown at left appears and the indicator LED goes off.

C/BS (BS) key ↑ ↓ **ENT** key



The checker pattern is reversed.

C/BS (BS) key ↑ ↓ **ENT key**

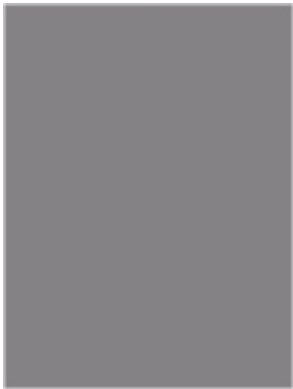

The gray screen appears with a one-dot wide white outline.

C/BS (BS) key ↑ ↓ **ENT key**

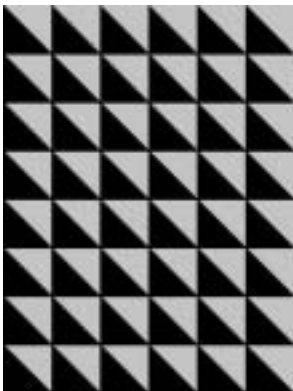

Forty eight right-angled triangles appear.

C/BS (BS) key ↑ ↓ **ENT key**



The gradation pattern appears.

Press the **ENT** key, and the BHT returns to the Hard Test menu.

[4.6] Key entry and vibrator test

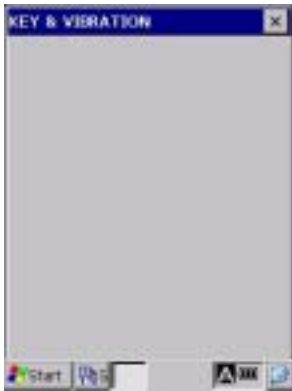

Selecting "6:KEY VIBRATION" on the Hard Test menu calls up the screen shown at left and makes the BHT ready for entry from the keypad.

Pressing individual keys displays the identifier letters in the positions pre-assigned to those keys on the LCD. Pressing the same key again erases the displayed letter.

The table below shows the relationship between the keys and the identifier letters to be displayed on the LCD.

Key	Letter	Key	Letter	Key	Letter
▲	^	1	1	F1	F1
▼	v	2	2	F2	F2
▲	>	3	3	F3	F3
▼	<	4	4	F4	F4
M1	M1	5	5	F5	F5
M2	M2	6	6	F6	F6
M3	M3	7	7	F7	F7
M4	M4	8	8	F8	F8
M5 *	M5	9	9	F9	F9
M3 halfwy pressed	M3H	0	0	F0	F0
M4 halfwy pressed	M4H	.	.		
M5* halfwy pressed	M5H	ENT	ENT		
SF/ALP (SF)	SF				
C/BS (BS)	BS				

*M5 available on the grip style BHT

(Note) Only when the **M1** or **M2** key is pressed, the vibrator works.



After all keys are pressed and displayed on the LCD, this test automatically ends and the screen returns to the Hard Test menu.

(M5 and M5H appear only on the grip style BHT.)

[5] Explorer

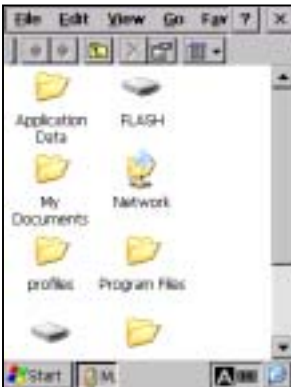

Choosing "5:Explorer" in System Menu calls up the screen shown at left.

[6] System Information



Choosing "6:Version" in System Menu calls up the screen shown at left.

2.6 Wireless Zero Configuration (WZC)



The screen on the left displays if a wireless local area network (wireless LAN) environment has not yet been established following purchase of the BHT unit. (BHT-202BW-CE only)

If this screen does not display, double-tap the Wireless Zero Configuration status icon in the task tray to display.

Wireless Zero Configuration status



Indicates that the Wireless Zero Configuration (WZC) radio is connected to a wireless network.



Indicates that the Wireless Zero Configuration (WZC) radio is not connected to a wireless network.

Synchronization state



Displays when the wireless device is open.





Shows the radio field intensity with the number of bars.

The WZC menu has the following tabs:

- IP Information: Displays information such as the IP address.
- Wireless Information: Used to perform wireless communication settings.



The radio field intensity icons (, , and ) indicate that the radio link is established but do not assure you that there will be few communications errors.

■ IP Information



Tapping the **IP Information** tab on the WZC Menu displays the screen shown at left.

Internet Protocol (TCP/IP) settings information displays at this menu.

Renew: Updates with the latest information.

Details: Displays detailed information.



Tapping the **Details...** button on the IP Information tab displays the screen shown at left.

Displays detailed information for the network settings.

Physical Address: Displays the MAC address for the BHT internal Network Interface Card.

IP Address: Displays the IP address.

Subnet Mask: Displays the subnet mask address.

Default Gateway: Displays the default gateway address.

DHCP Server: Displays the DHCP server address.

Lease Obtained: Displays the time and date at which the IP address was obtained from the DHCP server.

Lease Expires: Displays the time and date at which the IP Address became invalid.

DNS Servers: Displays the DNS servers address.

WINS Servers: Displays the WINS servers address.

Please refer to section 2.5.4 “Detailed Description of the Functions in System Menu [3.8] Radio Frequency” for details of settings for the IP address and so forth.

■ Wireless Information

Wireless Properties



Tapping the **Wireless Information** tab on the WZC Menu displays the screen shown at left.

The SSID list for which a search was performed automatically by the BHT displays.

If automatic recognition is not made, double-tap **Add New...** and manually input the SSID.

Please refer to section 3.1.2 “RF-Related Parameters” for further details on the SSID.

Tap the SSID for which a connection is to be made from the SSID list, and then tap the **Connect** button to begin connecting to the wireless network.



Double-tap an SSID from the SSID list in the **Wireless Information** tab to display the screen on the left.

Perform settings to connect to the wireless network.

You can set the following:

Network name (SSID):

Displays the SSID. Manually input the SSID if it is not automatically recognized.

This is an ad hoc network:

Do not check this check box because ad hoc mode is not supported.

Encryption:

Select the encryption mode.

Authentication:

Set the authentication system when the WEP is enabled.

Network key:

Enter the network key.

Key index:

Enter the network key index.

This key is provided automatically:

Select this check box to automatically obtain the network key.

Enable 802.1X authentication:

Select this check box to enable 802.1X authentication.

* This cannot be used in Ad hoc mode.

• Security and Setting Method

The security level can be changed based on combinations of the encryption and authentication. The setting parameters for each security level are shown in the table below.

Setting parameter	Security						
	None		PEAP (802.1x)	EAP-TLS (802.1x)	PEAP (WPA)	EAP-TLS (WPA)	PSK (WPA)
Encryption	Disabled	WEP	WEP	WEP	TKIP	TKIP	TKIP
Authentication	Open	Open	Open	Open	WPA	WPA	WPA-PSK
Network key	–	xxxxxx	–	–	–	–	xxxxxx
Key index	–	1 to 4	–	–	–	–	–
The key is provided automatically	–	*	√	√	–	–	–
Enable 802.1X authentication	–	*	√	√	–	–	–
EAP type	–	–	PEAP	TLS	PEAP	TLS	–

(Note)

– : No entry possible

√ : Select

* : No entry or no selection

xxxxxx : Enter the network key.

• **Settings when PEAP, TLS Selected for EAP Type**



Tapping the **Properties...** button on the Wireless Properties window displays the screen shown at left.

Displays the User Certificate issuance information.

Select the Validate Server check box to enable the certificate server.

Default: Enabled



When TLS is selected for the EAP type, tapping the **Select...** button on the Authentication Settings window displays the screen shown at left.

The Certificates list displays.

Tap a certificate from the list, and then tap the **View Certificate...** button to display detailed information.

Advanced Wireless Settings



Tap the **Advanced...** button from the Wireless Information tab to display the screen on the left.

Use Windows to configure my wireless settings:

Select this check box to automatically perform wireless network settings at Windows CE. This check box should always be selected.

Preferred Networks:

Displays the Preferred networks SSID list.

Tap an SSID and then tap either the Up or Down button to change the order in which the SSID displays in the list.

Tap an SSID and then tap the Delete button to delete that SSID from the list.

Try network connections shown on the “Preferred Networks” display, from the SSID at the top.

Automatically connect to non-preferred networks:

Select this check box to display accessible non-preferred networks, enabling a selection to be made.

Networks to access:

Used to select a network filter.

- | | |
|----------------------------|------------------------------|
| All available: | Both of following |
| Only access points: | Between BHT and access point |
| Only computer-to-computer: | Between BHT and other device |

If the “Automatically connect to non-preferred networks” check box is selected, this is applicable to both preferred networks and non-preferred networks. If the check box is not selected, it is applicable between preferred networks only.

Wireless Networking Log

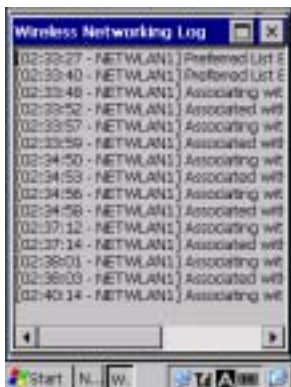

Tapping the **Log...** button on the Wireless Information tab calls up the Wireless networking Log.

The wireless networking log displays.

Communications Operations of the BHT-202B-CE/202BW-CE

Describes the communications operations of the BHT—the spread spectrum communication (BHT-202BW-CE only), infrared communication, USB interface specifications, connector interface specifications, basic communications specifications, communication using Ymodem, and ActiveSync—for data transfer with the host computer or other devices.

3.1	Spread Spectrum Communication	114
3.1.1	Notes for Wireless Operations	114
3.1.2	RF-Related Parameters	115
3.2	Infrared Communication	117
3.3	Connector interface specification	118
3.4	Basic Communications Specifications and Ymodem	120
3.4.1	Basic Communications Specifications	120
3.4.2	Using Ymodem	122
3.5	ActiveSync	123
3.5.1	Configuring the Host Computer	123
3.5.2	Connection Using ActiveSync	125

3.1 Spread Spectrum Communication

The BHT-202BW-CE supports spread spectrum communication.

3.1.1 Notes for Wireless Operations

- If there are too many communications errors, first make sure that the BHT-202BW-CE points directly at an access point because the 2.4-GHz band requires a more or less straight line path. Note also that the low-power radio waves have trouble passing through human bodies and other obstacles along that path.
- This link will not operate properly in the vicinity of microwave ovens, industrial heaters, high-frequency medical equipment, and other sources of radio waves in the 2.4-GHz band.
- Electromagnetic noise from personal computers, refrigerators, and other home appliances can also interfere with link operation.
- Environmental factors that can also interfere with link operation include large metallic objects, metallic dust, or metallic walls in the vicinity of the path and vibration at either end.

NOTE

To System Designers:

- Before developing the application, make sure that the intended environment is free of the interference factors above and thus actually capable of supporting link operation.
- Assume that there will be communications failures requiring robust retry capabilities in the software.
- When introducing the BHT link operation into an environment where equipment using radio waves in the 2.4-GHz band operates or when introducing such equipment after the introduction of the BHT link operation, be sure to confirm that the BHT radio link operates properly with all equipment being in operation beforehand.
- If the environment of the radio communications system is changed after the introduction (e.g., newly installed household appliances and movement/addition of shelves or objects), then confirm that the radio link operates properly again before the actual use.

3.1.2 RF-Related Parameters

Wireless communication between the BHT terminals and access points that are connected to each other by a wireless LAN are command-controlled by user programs.

For the setting procedure of RF-related parameters, refer to Section 2.5.4, "[3.4] RF Menu (Network Interface Control)."

■ ESSID (Extended Service Set ID)

An ESSID is an ID that identifies the wireless network. Wireless devices having a same ESSID can communicate with each other.

■ POWER

This parameter sets the power mode for the wireless module built in the BHT. The following six power modes are available.

Power mode	Power consuming state
Full	
Most*	
More	
Mid	
Less	
Least	

*Default

■ WEP (Wired Equivalent Privacy)

When WEP is ON, messages to be sent/received over the wireless LAN will be encrypted.

The WEP KEY uses 40-bit (10-digit hexadecimal) or 128-bit (26-digit hexadecimal) encryption word.

The BHT is able to definitely communicate with access points having the same WEP KEY.

■ AUTHENTICATE

This parameter sets up the authentication system to be applied when WEP is enabled. You can use either one of the two KEYS—OPEN and SHARED KEY to disable and enable the authentication, respectively. If WEP is disabled, choose OPEN so that communication is no longer possible.

■ WEP KEY

You can set four types of encryption keys (WEP KEY1 through WEP KEY4). If you enable WEP, choose any one of WEP KEY1 through WEP KEY4 as TRANSMIT KEY.

■ TRANSMIT KEY

You need to use the TRANSMIT KEY in order to choose and activate any one of the WEP KEY1 through WEP KEY4 already defined.

NOTE

If the size of the WEP KEY specified as a TRANSMIT KEY for the BHT is different from that for the access point, no communication is possible.

Setting example: Communication is possible

- BHT: WEP KEY1=128bit, TRANSMIT KEY=WEP KEY1
 Access point: WEP KEY1=128bit, TRANSMIT KEY=WEP KEY1
- BHT: WEP KEY1=128bit, WEP KEY3=128bit, TRANSMIT KEY=WEP KEY1
 Access point: WEP KEY1=128bit, WEP KEY3=128bit, TRANSMIT KEY=WEP KEY3

Setting example: Communication is not possible

- BHT: WEP KEY1=40bit, TRANSMIT KEY=WEP KEY1
 Access point: WEP KEY1=128bit, TRANSMIT KEY=WEP KEY1
- BHT: WEP KEY1=128bit, WEP KEY3=40bit,TRANSMIT KEY=WEP KEY1
 Access point: WEP KEY1=128bit, WEP KEY3=40bit,TRANSMIT KEY=WEP KEY3

3.2 Infrared Communication

The BHT has an integrated infrared (IR) communications device which enables wireless transfer of programs and data between the BHT and the host computer and between the BHTs, instead of the conventional wire transfer.

The IR communications device features the following:

- Wireless communications
- Small and lightweight design
- Freedom from the codes/regulations and licenses which differ from country to country, unlike radio devices

The BHT may communicate with other IrDA-compliant equipment just by aligning their IR ports with each other. The effective IR range and IR port angle may differ depending upon the target equipment, so observe the instructions given in manuals furnished with such equipment.

NOTE

If IR transfer fails, bring the BHT closer to the target station or change the IR port angle, and try again.

The BHT's IR communications device is IrDA-compliant. IrDA stands for Infrared Data Association, which has defined hardware (IrDA Serial Infrared Physical Layer Link) and communications protocols for IR communications.

The BHT's physical layer complies with the IrDA1.2, with a maximum transfer distance of 0.15 m (5.9 inches) and maximum transmission rate of 115.2 kbits per second.

3.3 Connector interface specification

The BHT-202BW-CE is equipped with a USB interface for interfacing with the host PC, and with a connector interface for communicating with the host PC.

(1) Specification

- USB1.1, Full-speed compliant
- RS-232C interface

(2) Connector : TCX3171 HOSIDEN

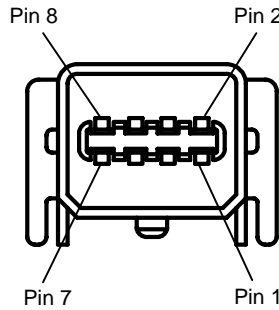

Pin No	Signal name	Data direction
1	GND	-
2	D+ (USB)	Input / Output
3	D- (USB)	Input / Output
4	VBUS (USB)	-
5	CTS (RS-232C)	Input
6	RxD (RS-232C)	Input
7	RTS (RS-232C)	Output
8	TxD (RS-232C)	Output

- (Note) 1.The input/output direction is stipulated from the BHT side.
 2.Use the exclusive cable only.

(3)-1 Interface circuit (USB)

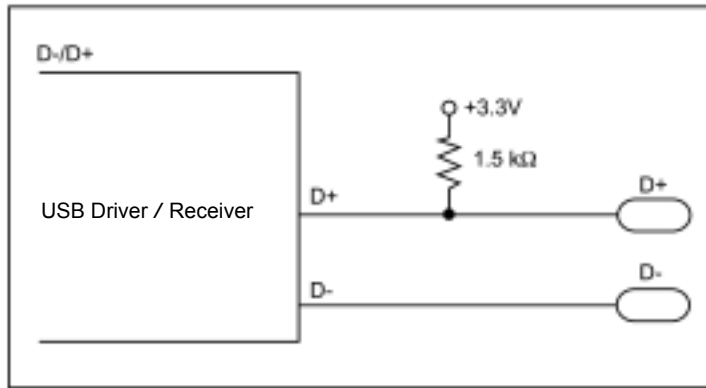

(3)-2 Interface circuit (RS-232C)

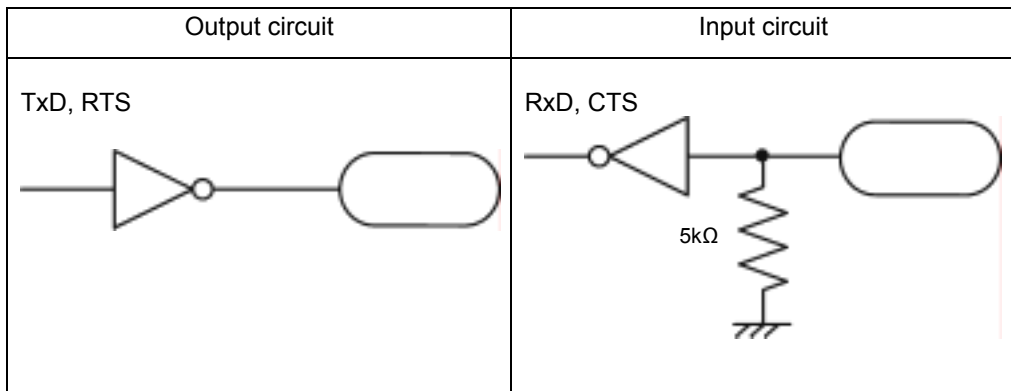

Signal Level

Item	Min.	Typ.	Max.
Output voltage "H" (3 KΩ load)	5V		15V
Output voltage "L" (3 KΩ load)	-15V		-5V
Input voltage "H"	3V		15V
Input voltage "L"	-15V		-3V

- (NOTE)(1) Input / Output voltage are specified at the terminal of the interface connector.
 (2) Output voltage becomes unsettled when the connector communication device file is closed.
 (3) Output voltage shall be under the following conditions :
 Power voltage: Rated voltage
 Load resistance: 3 k

3.4 Basic Communications Specifications and Ymodem

3.4.1 Basic Communications Specifications

Listed below are the communications specifications when the BHT exchanges data with a host computer through the CU-200 (IrDA interface) or the connector interface*.

	IrDA Interface	Connector Interface
Synchronization	Start-stop	
Transmission Speed	2400, 9600, 19200, 38400, 57600 or 115200 bps	300, 600, 1200, 2400, 4800, 9600, 19200, 38400, 57600 or 115200 bps
Transmission Code	ASCII 8-bit code	ASCII 7-bit or 8-bit code
Transmission Bit Order	LSB (Least significant bit) first	
Vertical Parity	None	Even, odd, or none

■ Synchronization

For accurate data transaction, it is very important to synchronize the transmission between the sender and receiver. To do this, it is required to previously define the bit order and position, the character length, and the beginning and end of the character to be transmitted.

The start-stop synchronization is an asynchronous system which synchronizes each character as a unit; that is, it externally adds start and stop bits to the leading and trailing bit positions of the character to be transmitted, respectively. A clock starts counting on receiving the start bit and it falls into a non-communication state on receiving the stop bit. The number of the stop bits is selectable (1 or 2 bits).

■ Transmission Speed

Maximum number of bits to be transmitted per second. Expressed in bps (bits per second).

■ IrDA Interface Communications Range

The IrDA interface's maximum effective range is 15 cm (5.9 inches) with the IR beam within a 10° angle of divergence.

To communicate via the CU-200, put the BHT on the CU-200.

■ Switching Time between Sending and Receiving on IrDA Interface

The IrDA interface should satisfy the following requirements in switching between sending and receiving:

- (1) Within 10 ms from completion of sending, the IrDA interface should become ready to receive.
- (2) After 10 ms or more from completion of receiving, the IrDA interface should start sending.

■ Transmission Code and Bit Order

All characters should be coded to 7 or 8-bit code for data transmission. The transmission bit order is LSB (Least significant bit) first.

What follows is an example for transmitting character A (41h, 01000001b) with an even parity and a single bit each for start and stop bits.



■ Vertical Parity

A vertical parity bit is a redundancy bit which is added to every character to be transmitted in order to check that data has been transmitted accurately. The parity bit should be set to "1" or "0" depending upon the parity parameter setting, to make the number of set bits in the character even or odd. The receiver counts the number of set bits in the transmitted character code to make sure that it has the selected number (even or odd) of set bits.

The vertical parity bit is positioned immediately following the MSB (Most significant bit) as shown below.

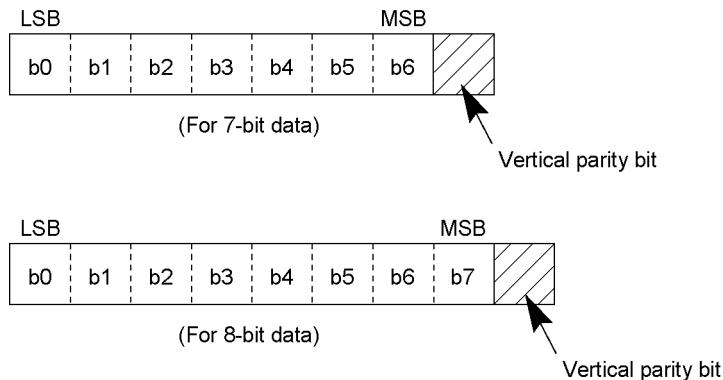

3.4.2 Using Ymodem

In System Menu and user programs, the BHT can use the Ymodem protocol with the following communications parameters:

Port	IrDA interface	Connector interface
Transmission Speed	2400, 9600, 19200, 38400, 57600 or 115200 bps	300, 600, 1200, 2400, 4800, 9600, 19200, 38400, 57600 or 115200 bps
Character Length	8 bits	8 bits
Vertical Parity	None	Even, odd, or none
Stop Bit Length	1 bit	1 or 2 bits

In System Mode

Refer to Section 2.5.4, "[2] Communication Menu."

In User Programs

Refer to the "BHT-200-CE API Reference Manual" or "BHT-200-CE Class Library Reference Manual."

3.5 ActiveSync

With Microsoft ActiveSync, the BHT can exchange data with the host computer connected by IrDA, USB, connector interface, or spread spectrum communication (BHT-202BW-CE).



ActiveSync enables the following:

- Synchronized data transmission
- Backing up data
- Copying or transferring data
- Debugging user programs

3.5.1 Configuring the Host Computer

You need a PC equipped with an IrDA interface port.



When the BHT is connected with the host via the CU-201 (RS-232C interface), no ActiveSync can be used.

The BHT and host computer should be arranged with their IrDA ports facing directly each other.

Installing ActiveSync 3.7

To use ActiveSync for communication between the BHT and host computer, you need to install ActiveSync 3.7 to the host computer.

Download ActiveSync 3.7 from the Microsoft Web site at:

<http://www.microsoft.com/downloads/details.aspx?FamilyID=67e9e87c-ca96-48b4-b5d4-f3e047ca5108&displaylang=en>

Setting up ActiveSync 3.7

Make ActiveSync connection settings according to the procedure below.



Start the installed ActiveSync 3.7, and the screen shown at left appears.

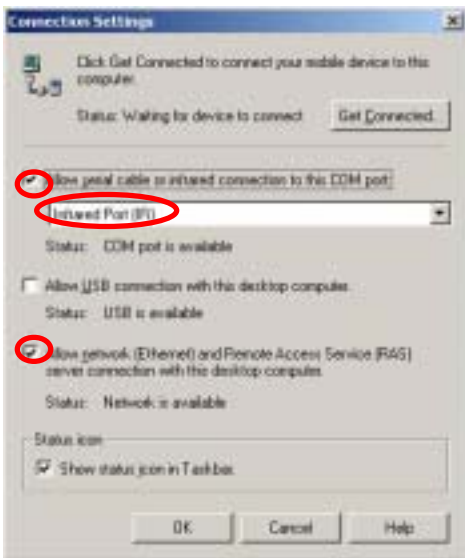

Choose **File|Connection Settings**. The screen shown at left appears.

Click the check box "Allow serial cable or infrared connection to this COM port:" and select "Infrared Port (IR)."

Click the check box "Allow network [Ethernet] and Remote Access Service [RAS] server connection with this desktop computer."

Tap **OK**.

Setting up ActiveSync 3.7 has been completed.

3.5.2 Connection Using ActiveSync

When connected by IrDA, USB, or connector interface

■ IrDA communication

Arrange the BHT and host computer with their IrDA ports facing directly each other as shown below. No ActiveSync can be used for connection via the CU-201 (RS-232C interface).

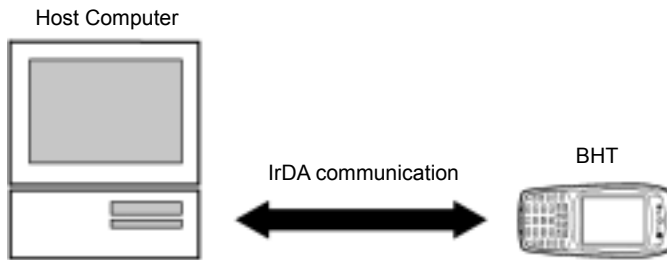

For the operating procedure of ActiveSync on the BHT, refer to Chapter 2, Section 2.5.4, "[2.2] ActiveSync (IrDA)."

■ USB communication

Connect the BHT to the host computer by using a USB interface cable as shown below.

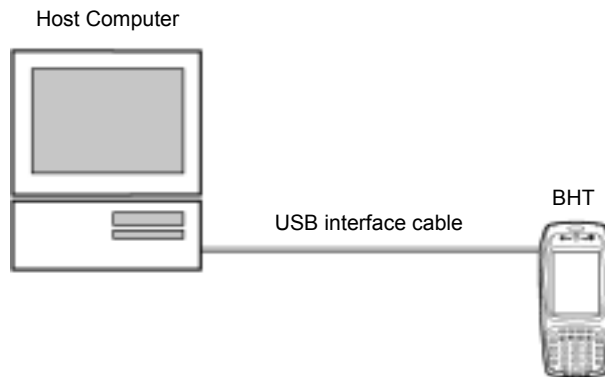

For the operating procedure of ActiveSync on the BHT, refer to Chapter 2, Section 2.5.4, "[2.4] ActiveSync (USB)."

■ Connector interface communication

Connect the BHT (connector interface port) to the host computer (RS-232C interface) by using a connector interface cable as shown below.

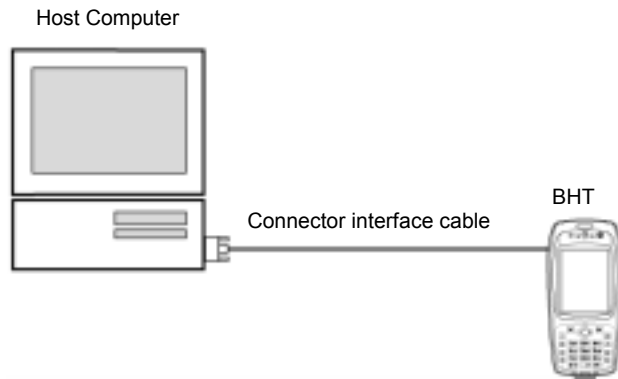

For ActiveSync operating procedures on the BHT, refer to Chapter 2, Section 2.5.4: "[2.5] ActiveSync (Serial)."

Setting up a partnership



Upon completion of connection between the host computer and BHT, the host computer displays the screen shown at left.

On this screen, set up a partnership between the host computer and BHT.

Click the **Yes** radio button and then click **Next**.



Type an arbitrary BHT name in the **Device name** box and click **Next**.



To synchronize files, select the **Files** check box and then click **Next**.





Click **Finish** to complete the setup and return to Windows.

The partnership between the BHT and host computer has been set up.

For instructions on how to use ActiveSync, refer to its Help on the host computer.

For debugging of user programs using ActiveSync, refer to the "BHT-200-CE API Reference Manual" or "BHT-200-CE Class Library Reference Manual."

In spread spectrum communication (BHT-200BW-CE/201BW-CE only)

Like ActiveSync in IrDA communication or USB communication, ActiveSync in spread spectrum communication requires a partnership between the BHT and host computer to be set up. Set up the partnership according to the operating procedure in IrDA communication or USB communication given on the previous page.

For the operating procedure of ActiveSync on the BHT, refer to Chapter 2, Section 2.5.4, "[2.3] ActiveSync (RF)."

NOTE

Depending upon the PC name (e.g., the PC name begins with a numeral), ActiveSync may not run in spread spectrum communication. It is recommended that the PC name be set with alphabets (A to Z and a to z) only.

Chapter 4

Error Messages

This chapter lists the error messages which will appear on the LCD if some error occurs in the BHT.

4.1 System Errors.....	131
------------------------	-----

4.1 System Errors

If some error occurs when the power is turned on or during program execution, one of the following error messages will appear on the LCD.

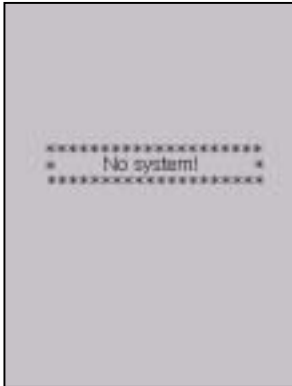

System Program error

■ Problem

A System Program error has occurred.

NOTE

If this error occurs, the BHT beeps five times (for 0.1 second per beep) and then turns itself off.

■ Solution

Contact your nearest dealer.

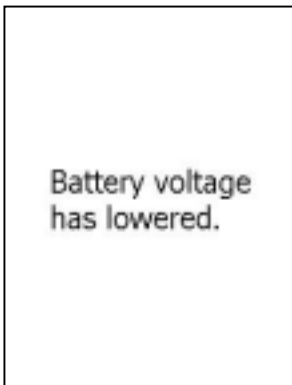

Low battery warning

■ Problem

When the power is turned on or off or during execution of applications, the battery output level has dropped below the specified lower level limit.

NOTE

If low battery is detected, the BHT displays this message for approx. 2 seconds and beeps three times (for 0.1 second per beep). After that, it will resume previous regular operation.

■ Solution

The battery cartridge will need to be recharged before long.

Replace or recharge the battery cartridge. (For the charging procedure, refer to Chapter 5, Section 5.5.)

If the grip style BHT is loaded with battery cartridges both in the BHT body and the grip, replace or recharge both battery cartridges. Always remove both battery cartridges, even if you only have one fully-charged replacement battery cartridge on hand.

Charge the Battery!

Shutdown due to low battery

■ Problem

When the power is turned on or off or during execution of applications, the battery output level has lowered so that the BHT no longer operates.

NOTE

If lower battery is detected, the BHT beeps five times (for 0.1 second per beep) and then turns itself off. Depending upon the battery level, the beeper may not sound five times.

■ Solution

Replace or recharge the battery cartridge. (For the charging procedure, refer to Chapter 5, Section 5.5.)

If the grip style BHT is loaded with battery cartridges both in the BHT body and the grip, replace or recharge both battery cartridges. Always remove both battery cartridges, even if you only have one fully-charged replacement battery cartridge on hand.



Service life warning for backup battery

■ Problem

The backup battery has been charged/discharged by the specified number of times so that the battery capacity lowers below the specified level.

■ Solution

Replace the backup battery. For the replacement procedure, refer to Chapter 2, Section 2.4.

This chapter describes the handling procedure of the communication unit CU-200, the interfacing with the host PC, and the charging of the rechargeable battery cartridge.

- 5.1 Functions of the CU-200135
- 5.2 Components and Functions136
- 5.3 Applying Power to the CU-200.....137
- 5.4 Communicating with the Host PC139
 - 5.4.1 Setting the Transmission Speed of the CU-200139
 - 5.4.2 Interface Cable Connection140
 - 5.4.3 Interfacing with the Host PC141
- 5.5 Charging the Rechargeable Battery Cartridge (using the CU-200)142
- 5.6 Interface Specifications144
 - [1] Interface Connector and Pin Assignment144
 - [2] Interface Cable Connection145

Chapter 5

Handling the CU-200 (Option)

5.1 Functions of the CU-200

The optical communication unit CU-200 series is available in two models: CU-201 and CU-221. The CU-200 series has the following functions:

(1) Data exchange function

The CU-201/221 exchanges data and programs between the BHT and the host PC.

Interface with the BHT: IrDA interface

Interface with the host PC: RS-232C (CU-201)
USB (CU-221)

(2) Battery cartridge charging function

The CU-200 charges the rechargeable battery cartridge loaded in the BHT.

NOTE: Before using the CU-221, you need to install the dedicated USB device driver stored in the CD-ROM that comes with the CU-221. For the installation/uninstallation procedure, refer to the guidebook that comes with the CU-221.

5.2 Components and Functions

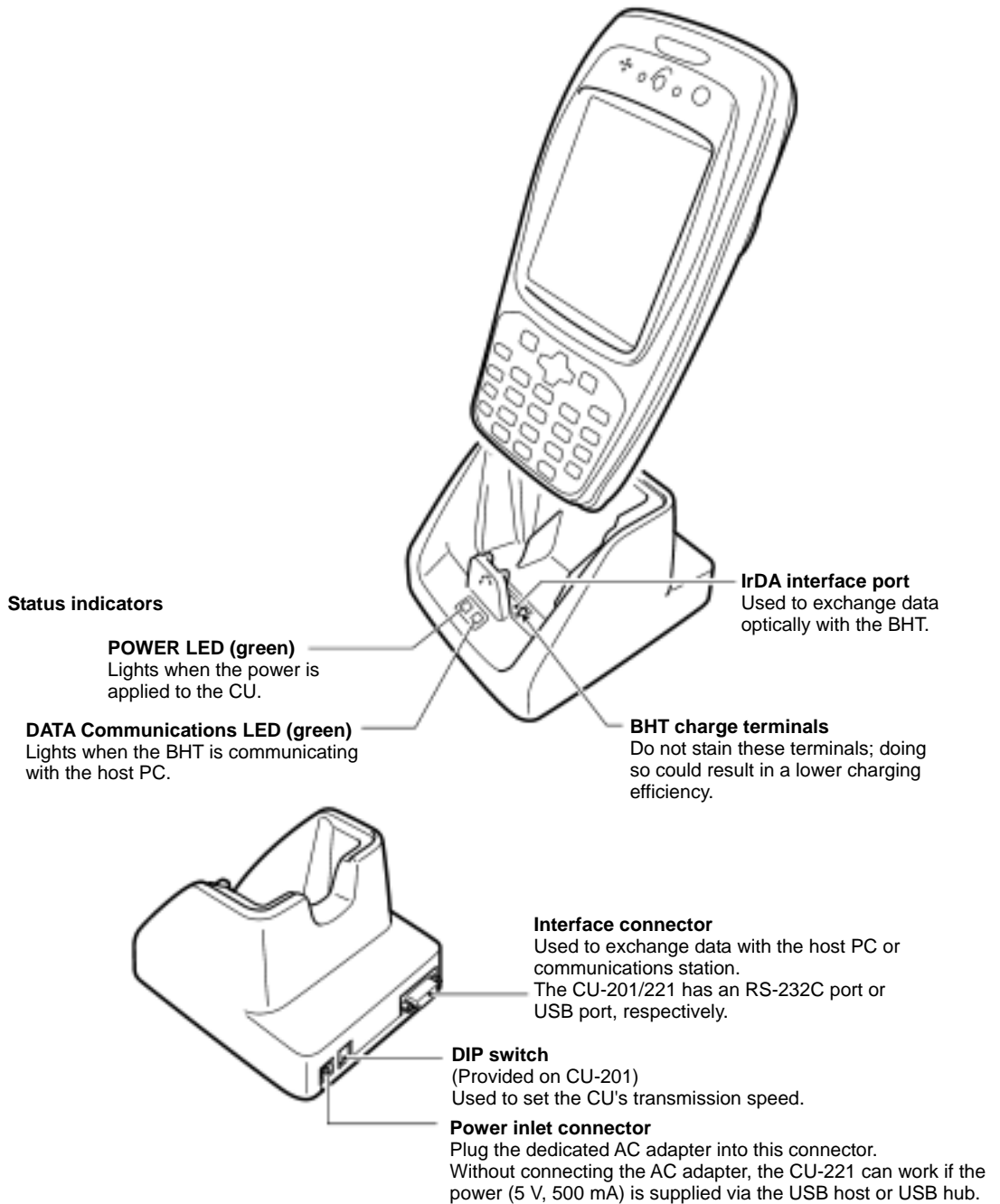

5.3 Applying Power to the CU-200

CU-201: The CU-201 should be powered from a wall socket via the dedicated AC adapter. Connect the outlet plug of the AC adapter to the power inlet connector of the CU-201, then plug the other end into a wall socket.

CU-221: The CU-221 should be powered from a wall socket via the dedicated AC adapter or from the USB host (PC) or USB hub via the USB interface.

Connecting the AC adapter supplies power to the CU-221. If no AC adapter is connected, turning on the USB host (PC) and USB hub supplies power to the CU-221.

NOTE: To charge the battery cartridge, use the AC adapter except when the CU-221 is connected to a self-powered hub capable of supplying power (5V 500 mA) via the USB line.

NOTE: To charge the battery cartridge even when the USB host (PC) is in suspend mode, use the AC adapter.

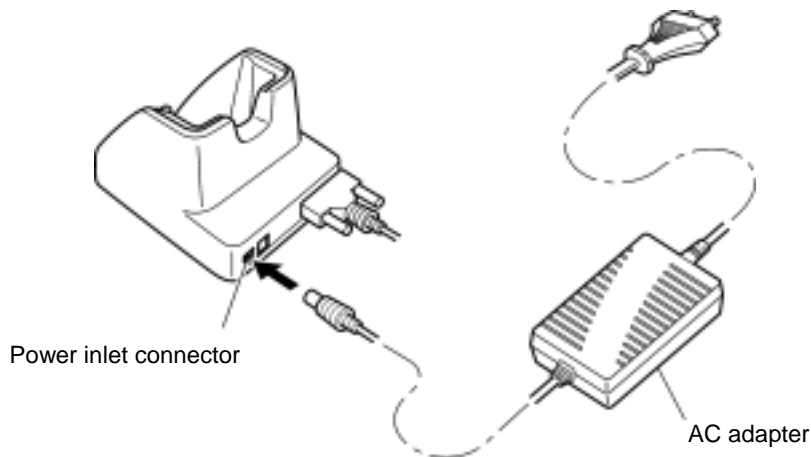

<p>⚠ WARNING</p>	<ul style="list-style-type: none"> • If smoke, abnormal odors or noises come from the CU, immediately unplug the AC adapter from the wall socket and contact your nearest dealer. Failure to do so could cause fire or electrical shock. • If foreign material or water gets into the CU, immediately unplug the AC adapter from the wall socket and contact your nearest dealer. Failure to do so could cause fire or electrical shock. • If you drop the CU so as to damage its housing, immediately unplug the AC adapter from the wall socket and contact your nearest dealer. Failure to do so could cause fire or electrical shock. • Use the dedicated AC adapter only. Failure to do so could result in a fire. • Never use the CU on the line voltage other than the specified level. Doing so could cause the CU to break or burn. • If the power cord of the AC adapter is damaged (e.g., exposed or broken lead wires), stop using it and contact your nearest dealer. Failure to do so could result in a fire or electrical shock. 	
-------------------------	---	--

 **CAUTION**

- If you are not using the CU for a long time, be sure to unplug the AC adapter from the wall socket for safety. Failure to do so could result in a fire.
- When caring for the CU, unplug the AC adapter from the wall socket for safety.
Failure to do so could result in an electrical shock.
- Never cover or wrap up the CU or AC adapter in a cloth or blanket. Doing so could cause the unit to heat up inside, deforming its housing, resulting in a fire.
Always use the CU and AC adapter in a well-ventilated area.
- Keep the power cord away from any heating equipment. Failure to do so could melt the sheathing, resulting in a fire or electrical shock.



5.4 Communicating with the Host PC

5.4.1 Setting the Transmission Speed of the CU-200

CU-201: Set the transmission speed to the same value as that of the BHT and host PC, by using the DIP switch.

CU-221: The transmission speed is automatically determined by the host PC.

The DIP switch is located next to the power inlet connector on the side of the CU-201.

- (1) Remove the protection sheet of the DIP switch from the CU-201.
- (2) Set the selectors of the DIP switch as shown below.

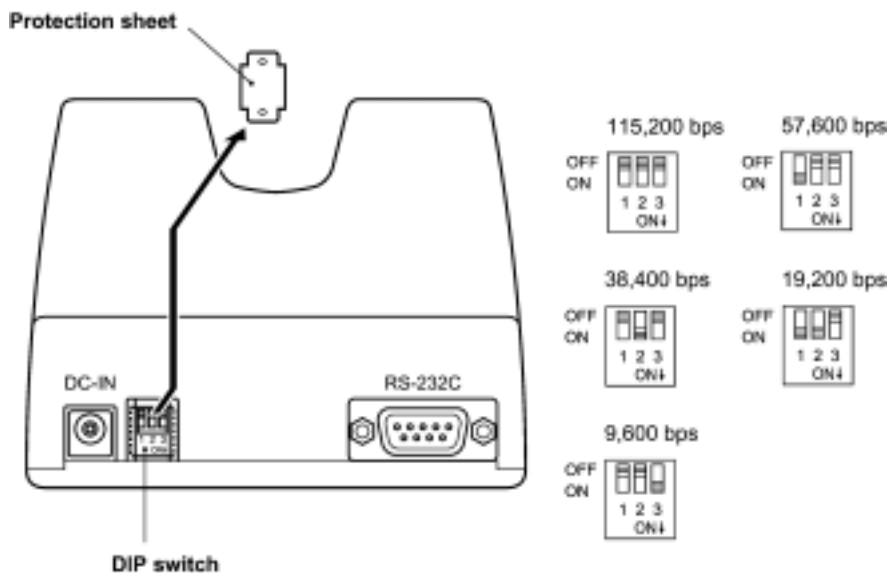

- (3) Reinstall the protection sheet.

NOTE

Do not set the DIP switch to any configurations other than one of the five shown above.

When removing the protection sheet, take care not to let any foreign material get into the CU.

5.4.2 Interface Cable Connection

- (1) Unplug the AC adapter of the CU-200 from the wall socket.
- (2) Make sure that the host PC is turned off.
- (3) CU-201: Connect the RS-232C interface cable to the interface port of the CU-201.
CU-221: Connect the USB interface cable to the interface port of the CU-221.

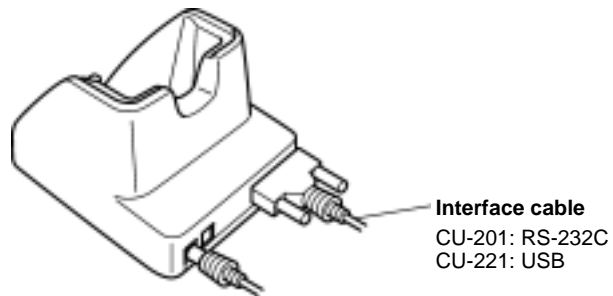

- (4) Connect the other end of the RS-232C/USB interface cable to the corresponding port of the host PC.

TIP: The CU-221 can be connected via a USB hub to the host PC.

5.4.3 Interfacing with the Host PC

This section describes how to start communication with the host PC from System Menu. The same may apply when you use a user program.

- (1) Turn the host PC on to run Windows.
- (2) CU-201: Plug the AC adapter into a wall socket.
CU-221: Plug the AC adapter into a wall socket, if necessary.
- (3) Make sure that the BHT is turned off and then place it on the CU-200.

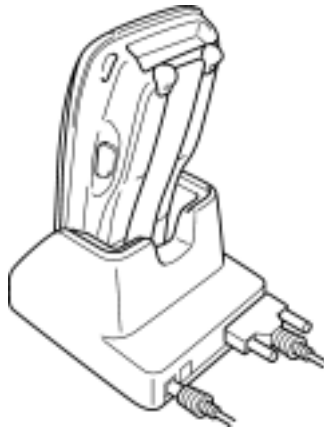

For CU-201 and CU-221

- (4) On the host PC, initiate a communications program that can use Ymodem.
- (5) Turn the BHT on and run System Menu. Select "2:Communication" and "1:Ymodem" to start "SerialTransfer."

Regarding the interface port: Select the "IrDA (COM4):."

- (6) To transfer data stored in the BHT to the host PC, select "UPLOAD." To transfer data from the host PC to the BHT, select "DOWNLOAD." (For details, refer to Chapter 2, Section 2.5.3 "Operating in System Menu.")

The BHT and the host PC will start communication with each other via the CU-200. The DATA LED on the CU-200 will come on upon start of communication. After completion of communication, the LED will go off.

CU-221 only

- (4) Connect the USB cable to the USB ports on the host PC and the CU-221.
- (5) Turn the BHT on and run System Menu. Select "2:Communication" and "ActiveSync (USB)."
- (6) Once the connection is complete, "My Computer" and "Mobile Device" can be viewed allowing data exchange between the host PC and the BHT.

5.5 Charging the Rechargeable Battery Cartridge (using the CU-200)

You can charge a rechargeable battery cartridge loaded in the BHT.

NOTE Be sure to turn the BHT off before starting charging.

NOTE Service Life of Rechargeable Battery Cartridge:

Lithium-ion batteries used in the rechargeable battery cartridge will gradually deteriorate during the repeated cycles of charging and discharging due to its properties, even under normal use. When the battery service period becomes shortened due to its deterioration even if it has been charged for the specified hours, replace the battery cartridge with a new one. Generally, it is necessary to replace the battery cartridge after it has undergone approx. 300 cycles of charging and discharging operation.

(1) Turn the CU-200 on.

The POWER LED on the CU-200 lights in green.

(2) Turn the BHT off and place the BHT loaded with a battery cartridge onto the CU-200.

The BHT turns on the charge LED in red and starts charging.

Charging time



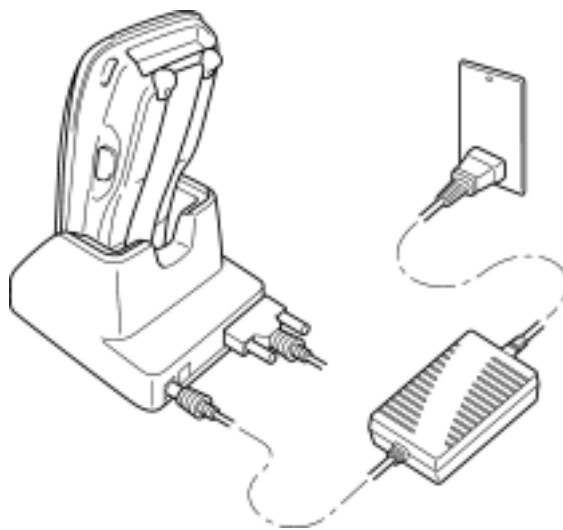

When power is supplied via:	Regular style BHT	Grip style BHT with two battery cartridges loaded
AC adapter (CU-201/221)	Approx. 3 hours	Approx. 5.5 hours
USB interface (CU-221)	Approx. 9 hours	Approx. 21 hours

Upon completion of charging, the charge LED turns green.

(3) Take the BHT off the CU-200.



■ Charging Operation and LED Indication

Operator's Action	CU-200 Status	Charge LED on the BHT
	On standby	 OFF
	⇓	
Place the BHT on the CU-200.	Charging	 ON (in red)
⇓	⇓	
<p>After approx. 3 hours (approx. 5.5 hours*) when the CU-201/221 is powered from the AC adapter</p> <p>After approx. 9 hours (approx. 21 hours*) when the CU-221 is powered from the USB interface</p>	Charging completed	 ON (in green)
⇓	⇓	
Remove the BHT.	On standby	 OFF

*For grip style BHTs with two battery cartridges loaded.

If the CU-221 is self-powered via the USB interface from the USB host (PC) or USB hub and the host PC is in suspend mode, the CU-221 cannot charge the battery cartridge.

If the host PC switches to the suspend mode when the CU-221 is charging the battery cartridge, then the CU-221 stops charging. When the host PC recovers from suspend mode, the CU-221 starts charging again. To prevent the CU-221 from getting affected by suspend mode, use the dedicated AC adapter.

5.6 Interface Specifications

[1] Interface Connector and Pin Assignment

CU-201

The CU-201 has an RS-232C interface port (Dsub-9P).

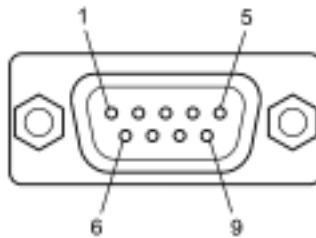

RS-232C interface port (Dsub-9P) on the CU-201

Pin No.	Signal	Functions	Signal Input/Output	
			CU-201	External device
2	RD	Receive data		←
3	SD	Send data		→
4	ER	Data terminal equipment ready		→
5	SG	Signal ground		—
6	DR	Data set ready		—
7	RS	Request to send		—
8	CS	Ready to send		—

The input/output voltage threshold for the logical valued signal is listed below.

Logical Value	Input Voltage Threshold	Output Voltage Threshold
0	$3V \leq n \leq 15V$	5V min.
1	$-15V \leq n \leq -3V$	-5V max.

CU-221

The CU-221 has a Full-Speed USB 1.1-capable port (Series B receptacle).

[2] Interface Cable Connection

CU-201

As illustrated below, connect the CU-201 (on which the BHT is put) to a host PC with a cross-mode cable. To connect it to a modem, use a straight-mode cable.

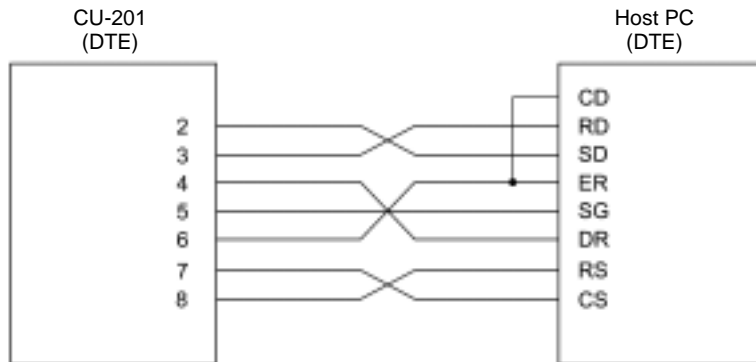

Cable Connection between CU-201 and Host PC



Cable Connection between CU-201 and Modem

DTE and DCE

In the RS-232C interface specifications, the DTEs (Data Terminal Endpoint) shall be generally connected with each other by a cross-mode cable; the DTE and DCE (Data Circuit Endpoint) shall be connected with each other by a straight-mode cable.

The DTE is one piece of equipment connected at both ends of a communications line as a sender or receiver of data (such as CU-201 on which the BHT is put and a host PC).

The DCE is one piece of equipment connected in-between the DTE and the communications line and terminates communications lines. It converts their signals without any change in contents (such as modem or TA).

CU-221

Use a cable that conforms to the USB specification.

Appendix A. Specifications	147
A.1 BHT-202B-CE/202BW-CE	147
[1] Product Specifications	147
[2] Bar Code Specifications.....	148
A.2 CU-200	151
[1] Product Specifications	151
[2] Charging Requirements	151
[3] Interface Specifications.....	152
Appendix B. Loading an Optional Compact Flash Card	153
Appendix C. Quality Assurance Standards	157
C.1 Interface Cables.....	157

Appendices

Appendix A. Specifications

A.1 BHT-202B-CE/202BW-CE

[1] Product Specifications

Power Source	Main power	Rechargeable lithium-ion battery cartridge (3.7 VDC)
Dimensions (W) x (L) x (H)		90 x 186 x 44 mm (3.5 x 7.3 x 1.7 inches)
Weight	Regular style BHT	Approx. 380 g (Approx. 13.4 oz.) including battery cartridge
	Grip style BHT	Approx. 450 g (Approx. 15.9 oz.) including battery cartridge loaded in the BHT body only
Operating Ambient Temperature		-5°C to 50°C (23°F to 122°F)
Operating Humidity		20% to 80% (with no dew condensation)
Ambient Illuminance		20 to 10,000 lx. (Depth of field: 700 mm, ITF: 0.625 magnification, PCS value: 0.9 min., Reflection intensity: 85% min. for white and 5% max. for black)
		500 to 3000 lx (Depth of field: 40 mm, PCS value: 0.9 min., Reflection intensity: 85% min. for white and 5% max. for black, Narrow bar width: 0.33 mm min.)
Controller		CPU: 32-bit RISC RAM: 128MB Flash memory: 64MB
Keypad		<u>30-key pad</u> Trigger switches (M3, M4): 2 Magic keys (M1, M2): 2 Numerical keys and others: 26
		<u>26-key pad</u> Trigger switches (M3, M4): 2 Magic keys (M1, M2): 2 Numerical keys and others: 22
Display	Type:	Touch screen, dot-matrix, TFT liquid crystal display (LCD) with backlight
	Formation:	240 dots wide by 320 dots high
Calendar Clock		Year, month, day, hour, minute, and second Year: Two digits (with auto-correction on February 29)
Reading Confirmation		Indicator LED (Red & blue), beeper, and vibrator

[2] Bar Code Specifications

(1) Available Bar Code Types

Bar code type	Bar dimensions	Readable magnification
Universal product codes	0.26 mm min. (10.24 mils min.)	0.8 min.
EAN-13		
EAN-8		
UPC-A		
UPC-E		
EAN-13 with add-on		
EAN-8 with add-on		
UPC-A with add-on		
UPC-E with add-on		
2-digits add-on		
5-digits add-on		
Interleaved 2of5 (ITF)	0.15 mm min. (5.91 mils min.) (PCS value ≥ 0.45)	
Standard 2of5 (STF)		
Codabar (NW-7)		
Code 39		
Code 93		
Code 128 (EAN-128)		

(2) Optical Properties Required

White bars: Reflection intensity 45% min.

Black bars: Reflection intensity 25% max.
PCS value 0.45 min.

(3) Bar Code Label Size

Recommended width: 10 mm min. (0.39 inch min.)

Length:

Depth of field (Distance from bar codes to the reading window)	Length of labels (including margins)
700 mm (27.56 inches)	400 mm max. (15.75 inches max.) (Minimum narrow bar width: 0.635 mm min.)* ⁶



(4) Thickness of Bars and Depth of Field

Minimum narrow bar width	Depth of field
0.15 mm (5.91 mils)	110 to 160 mm (4.33 to 6.30 inches) ¹
0.19 mm (7.48 mils)	100 to 205 mm (3.94 to 8.07 inches) ²
0.25 mm (9.84 mils)	75 to 310 mm (2.95 to 12.20 inches) ³
0.33 mm (12.99 mils)	40 to 450 mm (1.57 to 17.72 inches) ⁴
0.50 mm (19.69 mils)	45 to 620 mm (1.77 to 24.41 inches) ⁵
0.635 mm (25.00 mils)	45 to 700 mm (1.77 to 27.56 inches) ⁶
1.00 mm (39.37 mils)	70 to 895 mm (2.76 to 35.24 inches) ⁷

*¹ Under the following conditions:
 - Ambient illuminance: 500 lx. (Xenon arc lamp)
 - Code 39, 14-digit
 Narrow bar : Wide bar = 1 : 2.2
 - Reflection intensity of white bars: 85% min.
 Reflection intensity of black bars: 5% max.

*² Under the following conditions:
 - Ambient illuminance: 500 lx. (Xenon arc lamp)
 - Code 39, 5-digit
 Narrow bar : Wide bar = 1 : 2.2
 - Reflection intensity of white bars: 85% min.
 Reflection intensity of black bars: 5% max.

*³ Under the following conditions:
 - Ambient illuminance: 500 lx. (Xenon arc lamp)
 - Code 39, 20-digit
 Narrow bar : Wide bar = 1 : 2.2
 - Reflection intensity of white bars: 85% min.
 Reflection intensity of black bars: 5% max.

*⁴ Under the following conditions:
 - Ambient illuminance: 500 lx. (Xenon arc lamp)
 - Code 39, 20-digit
 Narrow bar : Wide bar = 1 : 2.2
 - Reflection intensity of white bars: 85% min.
 Reflection intensity of black bars: 5% max.

*⁵ Under the following conditions:
 - Ambient illuminance: 500 lx. (Xenon arc lamp)
 - Code 39, 15-digit
 Narrow bar : Wide bar = 1 : 2.2
 - Reflection intensity of white bars: 85% min.
 Reflection intensity of black bars: 5% max.

*⁶ Under the following conditions:
 - Ambient illuminance: 500 lx. (Xenon arc lamp)
 - ITF conforming to the UPC Shipping Container Code
 - Reflection intensity of white bars: 85% min.
 Reflection intensity of black bars: 5% max.
 - 0.625 magnification

*⁷ Under the following conditions:
 - Ambient illuminance: 500 lx. (Xenon arc lamp)
 - ITF conforming to the UPC Shipping Container Code
 Narrow bar : Wide bar = 1 : 2.2
 - Reflection intensity of white bars: 85% min.
 Reflection intensity of black bars: 5% max.
 - 1.0 magnification

Connector Interface

Specification: USB1.1, Full-speed compliant, RS-232C interface
 Connector: TCX3171 HOSIDEN
 Pin assignment: See below.

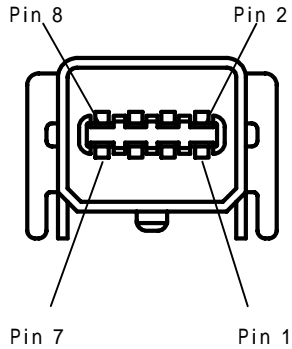

Pin No	Signal name	Data direction
1	GND	-
2	D+ (USB)	Input / Output
3	D- (USB)	Input / Output
4	VBUS (USB)	-
5	CTS (RS-232C)	Input
6	RxD (RS-232C)	Input
7	RTS (RS-232C)	Output
8	TxD (RS-232C)	Output

(Note) 1.The input/output direction is stipulated from the BHT side.
 2.Use the exclusive cable only.

Wireless Interface (BHT-202BW-CE only)

Specification: Spread Spectrum (Direct Sequence Spread Spectrum)
 Standards: RCR STD-33, ARIB STD-T66
 Radio frequency: 2400 to 2497MHz
 Transmission speed: 11Mbps/5.5Mbps/2Mbps/1Mbps
 Channel(s): 14

A.2 CU-200

[1] Product Specifications

	CU-201	CU-221
Power Source	100 to 240 VAC, 50/60 Hz, 0.2 A (5 VDC: Use AC adapter)	Supplied via the USB cable*
Power Consumption (AC adapter output)	5 VDC, 1500 mA	5 VDC, 500 mA
Dimensions (W) x (L) x (H)	114 x 140 x 87 mm (4.49 x 5.51 x 3.43 inches)	114 x 134 x 87 mm (4.49 x 5.27 x 3.43 inches)
Weight	Approx. 210 g (Approx. 7.41 oz.)	
Operating Ambient Temperature	0°C to 40°C (32°F to 104°F)	
Operating Humidity	20% to 80% (with no dew condensation)	

*NOTE: Can be powered from a wall socket via the dedicated AC adapter.

[2] Charging Requirements

CU-201/CU-221 (When using the AC adapter)

Charge current: Approx. 790 mA
 Charge time: Approx. 3 hours (approx. 5.5 hours)*.

CU-221 (When powered via the USB cable)

Charge current: Approx. 210 mA
 Charge time: Approx. 9 hours (approx. 21 hours)*.

*For grip style BHTs with two battery cartridges loaded.

[3] Interface Specifications

CU-201

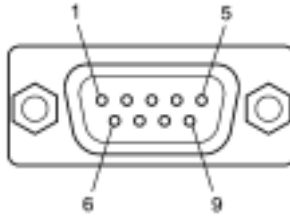

RS-232C interface port (Dsub-9P) on the CU-201

Pin No.	Signal	Functions	Signal Input/Output CU-201 External device
2	RD	Receive data	←
3	SD	Send data	→
4	ER	Data terminal equipment ready	→
5	SG	Signal ground	—
6	DR	Data set ready	—
7	RS	Request to send	—
8	CS	Ready to send	—

NOTE Shown below is a diagram of the internal connection in the CU-201.

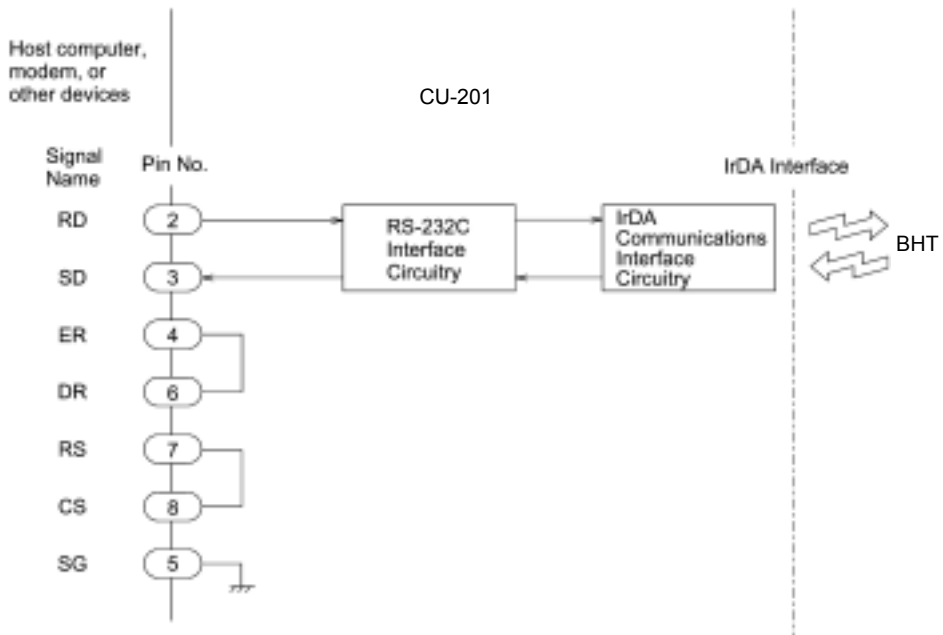

CU-221

The USB interface on the CU-221 is USB1.1 (Full-speed) compliant with a type-B receptacle.

Appendix B. Loading an Optional Compact Flash Card

Load an optional Compact Flash card to the BHT using the following procedure.

- (1) Turn the BHT upside down.
- (2) Slide the right and left release buttons in the direction of the arrows to remove the battery cartridge cover.

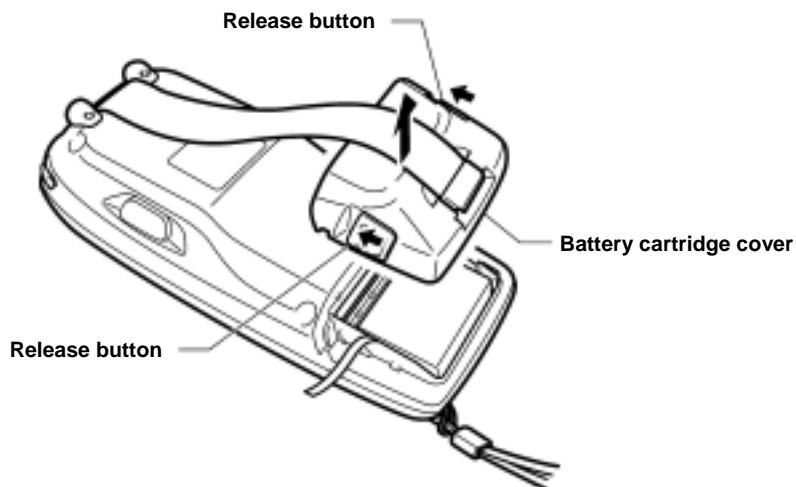

- (3) Pull up the battery pull strap to remove the battery cartridge.

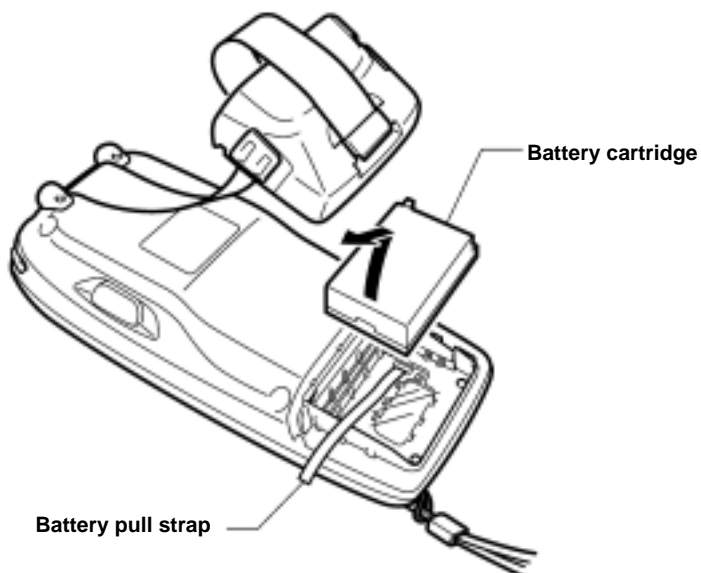

(4) Pull the lock of the inside cover to the right and towards you to release it.

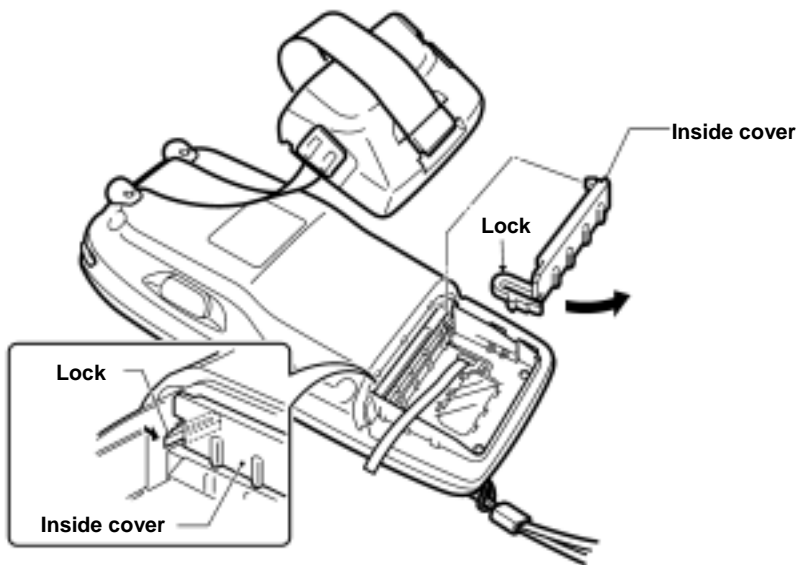

(5) Insert a Compact Flash card into the slot with the connector facing the slot and with the top facing down.

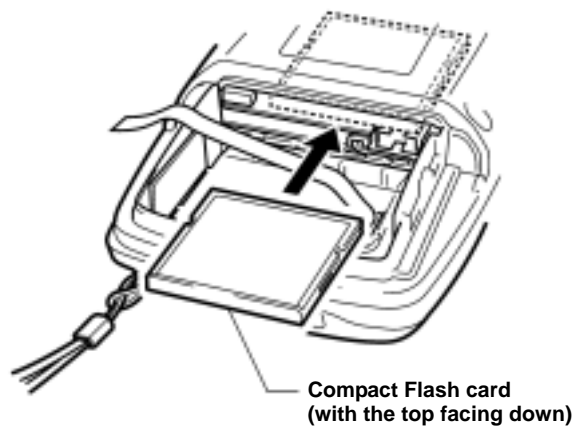

To remove the Compact Flash card, press the card release button provided at the left of the card as shown below.

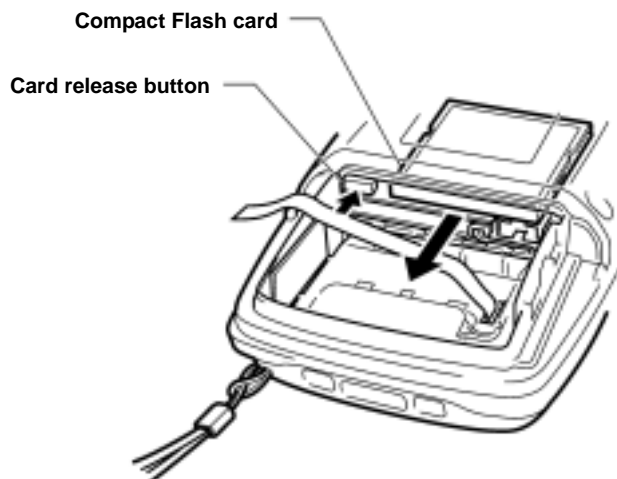

(6) Set the inside cover so that its lock and pawl become fitted between the printed circuit boards.

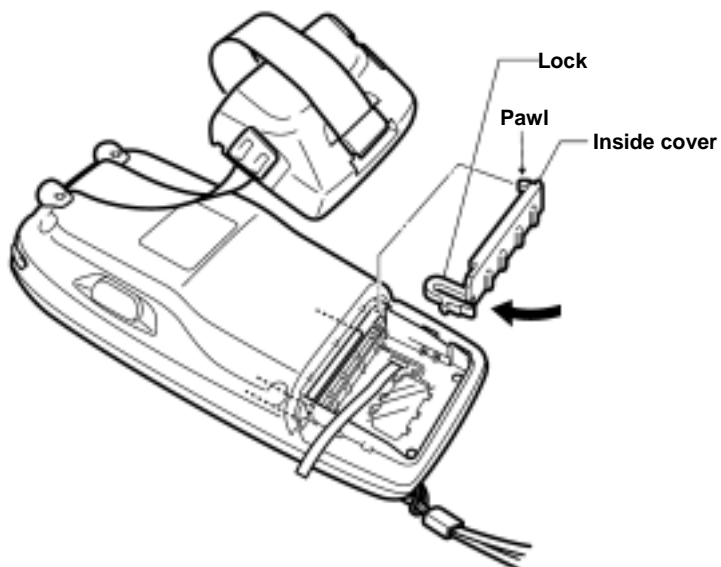

- (7) Push the battery cartridge into the BHT. The end of the battery pull strap should come out from the left edge of the battery cartridge.

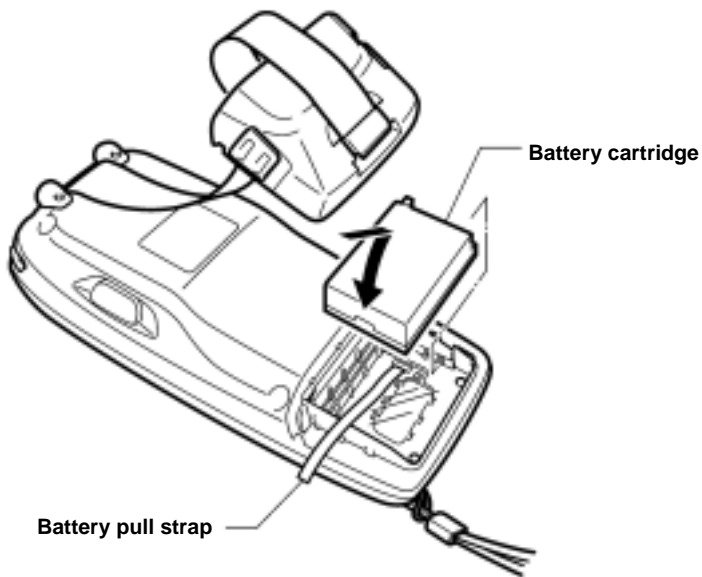

- (8) Set the battery cartridge cover back into place and return the right and left release buttons to the original position.

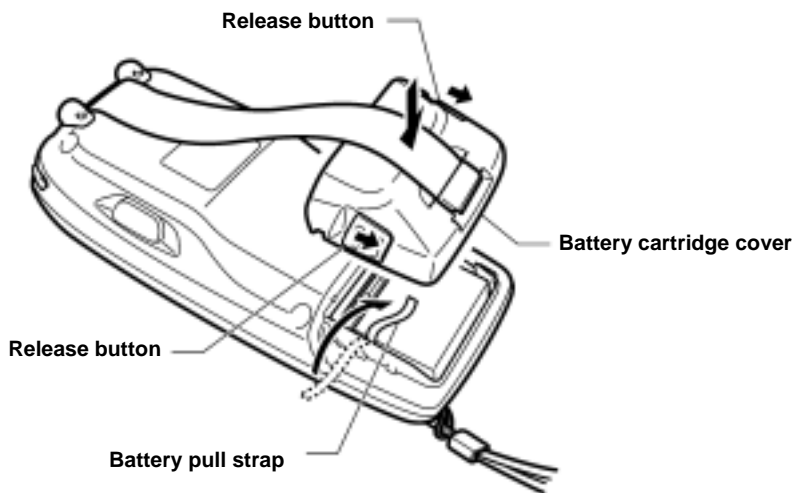

Appendix C. Quality Assurance Standards

C.1 Interface Cables

With the interface cables described in this section, DENSO WAVE has run the quality assurance test conforming to the EMC Directive for the BHT-202B-CE/202BW-CE and CU-200.

Any connectors other than those specified here are not acceptable. They may cause the BHT or CU to fail to work according to the specifications.

Cable



① Dsub connector Dsub-9S

② Shielded cable

BHT-202B-CE/202BW-CE

User's Manual

First Edition, June 2006

DENSO WAVE INCORPORATED

The purpose of this manual is to provide accurate information in the handling and operating of the BHT-202B-CE/202BW-CE. Please feel free to send your comments regarding any errors or omissions you may have found, or any suggestions you may have for generally improving the manual.

In no event will DENSO WAVE be liable for any direct or indirect damages resulting from the application of the information in this manual.